

Compact resistance thermometer

TR36 type



Art. No. 148323

Type No. TR36.100.3.A.12.100



Exemplary illustration

Resistance thermometers of these series are used as universal thermometers for the measurement of liquid and gaseous media. It consists of a probe tube, which can be fixed into the process. All electrical components are protected against splash water and designed to withstand vibration.

Technical data

WIKA type	TR36
Housing	CrNi steel 1.4571
Indicating range	-30 to 150 °C
Ambient temperature	-40 to 85 °C
Protection IP	IP 65
Accuracy	class A
Output signal	Pt100, 3-wire
Installation length	100 mm
Thread	G 1/2 ET
Wetted parts	CrNi steel 1.4571
Electrical connection	angular connector form A
Angular connector material	PA

Other special versions with different insertion lengths, process connections, sensors and connection methods can be individually selected for the respective application and are available on request.

Commercial data

Customs tariff number	90251900
Country of origin	PL
eCl@ss 5.1.4	27270101
eCl@ss 9.0	27270101
UNSPSC_Code_v190501	41112205
UNSPSC_CodeDesc_v190501	Temperature sensors

Resistance thermometer Threaded, compact version Model TR36

WIKA data sheet TE 60.36

Applications

- Machine building, plant and vessel construction
- Propulsion technology, hydraulics

Special features

- Sensor range -50 ... +250 °C [-58 ... +482 °F]
- Compact design
- Electrical connection via angular connector DIN EN 175301-803 form A
- With direct sensor output (Pt100 in 2-, 3- or 4-wire connection) or integrated transmitter
- Integrated transmitter with 4 ... 20 mA output signal, individually parameterisable with free-of-charge WIKAsoft-TT PC configuration software



Threaded resistance thermometer, model TR36

Description

Resistance thermometers of these series are used as universal thermometers for the measurement of liquid and gaseous media in the range -50 ... +250 °C [-58 ... +482 °F].

They can be used for pressures up to 140 bar [2,030 psi] with 3 mm [0.12 in] protection tube diameters, up to 270 bar [3,916 psi] with 6 mm [0.24 in] protection tube diameters, and up to 400 bar [5,801 psi] with 8 mm [0.31 in] protection tube diameters, depending on the instrument version. All electrical components are protected against splash water and designed to withstand vibration (8 g, depending on instrument version).

The TR36 resistance thermometer consists of a probe tube, which can be fixed into the process using a permanently welded threaded connection or a compression fitting. A version without process connection is also available.

The instrument version with integrated transmitter can be configured individually via the WIKAsoft-TT PC configuration software. Measuring range, dampening, error signalling per NAMUR NE 043 and TAG no. can be adjusted.

WIKA data sheet TE 60.36 · 02/2022

Page 1 of 7

Data sheets showing similar products and accessories:
Resistance thermometer, compact version; model TR30; see data sheet TE 60.30
Miniature resistance thermometer, explosion-protected version; model TR34; see data sheet TE 60.34
OEM threaded thermometer with plug connection; model TF35; see data sheet TE 67.10



Specifications

Measuring element		
Type of measuring element		
Version 4 ... 20 mA	Pt1000 (measuring current < 0.3 mA; self-heating can be ignored)	
Version Pt100	Pt100 (measuring current 0.1 ... 1.0 mA)	
	→ For detailed specifications for Pt sensors, see Technical information IN 00.17 at www.wika.com .	
Connection method		
Version 4 ... 20 mA	2-wire	
Version Pt100	2-wire	The lead resistance is recorded as an error in the measurement
	3-wire	With a cable length of 30 m or longer, measuring deviations can occur
	4-wire	The lead resistance can be ignored
Tolerance value of the measuring element ¹⁾ per IEC 60751		
Version 4 ... 20 mA	Class A	
Version Pt100	<ul style="list-style-type: none"> ■ Class A ■ Class B at 2-wire 	

Accuracy specifications (4 ... 20 mA version)	
Tolerance value of the measuring element ¹⁾ per IEC 60751	Class A
Measuring deviation of the transmitter per IEC 62828	±0.25 K or 0.25 % of the set span (greater value applies)
Total measuring deviation per IEC 62828 ²⁾	Measuring deviation of the measuring element + transmitter
Influence of ambient temperature	0.1 % of the set measuring span / 10 K T _a
Influence of supply voltage	±0.025 % of the set measuring span / V (depending on the supply voltage U _B)
Influence of load	±0.05 % of the set measuring span / 100 Ω
Linearisation	Linear to temperature per IEC 60751
Output error	±0.1 % ³⁾ of the set measuring span
Reference conditions	
Ambient temperature T _a ref	23 °C
Supply voltage U _B ref	DC 24 V

1) Depending on the process connection, the deviation can be bigger.

2) During transient interferences (e.g. burst, surge, ESD) take into account an increased measuring deviation of up to 2.5 %.

3) ±0.2 % for start of measuring range less than 0 °C [32 °F]

Example calculation: Total measuring deviation

(measuring range 0 ... 150 °C, load 200 Ω, supply voltage 20 V, ambient temperature 33 °C, process temperature 100 °C)

Sensor element (class A per IEC 60751: 0.15 + (0.0020(t))):	±0.350 K
Measuring deviation of the transmitter ±0.25 K:	±0.250 K
Output error ±(0.1 % of 150 K):	±0.150 K
Influence of load ±(0.05 % / 100 Ω of 150 K):	±0.150 K
Influence of supply voltage ±(0.025 % / V of 150 K):	±0.150 K
Influence of ambient temperature ±(0.1 % / 10 K T _a of 150 K):	±0.150 K

Measuring deviation (typical)

$$\text{sqrt}(0.35 \text{ K}^2 + 0.25 \text{ K}^2 + 0.15 \text{ K}^2 + 0.15 \text{ K}^2 + 0.15 \text{ K}^2 + 0.15 \text{ K}^2)$$

$$\text{sqrt}(0.275 \text{ K}^2) = 0.524 \text{ K}$$

Measuring deviation (maximum)

$$0.35 \text{ K} + 0.25 \text{ K} + 0.15 \text{ K} + 0.15 \text{ K} + 0.15 \text{ K} + 0.15 \text{ K} = 1.2 \text{ K}$$

Measuring range	
Temperature range	
Version 4 ... 20 mA	Without neck tube -30 ... +150 °C [-22 ... +302 °F] With neck tube -30 ... +250 °C [-22 ... +482 °F] ¹⁾
Version Pt100	Class A Without neck tube -30 ... +150 °C [-22 ... +302 °F] With neck tube -30 ... +250 °C [-22 ... +482 °F] ¹⁾
	Class B Without neck tube -50 ... +150 °C [-58 ... +302 °F] With neck tube -50 ... +250 °C [-58 ... +482 °F] ¹⁾
Unit (4 ... 20 mA version)	Configurable °C, °F, K
Temperature at the connector (Pt100 version)	Max. 85 °C [185 °F]
Measuring span (4 ... 20 mA version)	Minimum 20 K, maximum 300 K

1) The temperature transmitter should therefore be protected from temperatures over 85 °C [185 °F].

Process connection	
Type of process connection	<ul style="list-style-type: none"> ■ G ¼ B ■ G ⅜ B ■ G ½ B ■ ¼ NPT ■ ½ NPT ■ M12 x 1.5 ■ M20 x 1.5
Protection tube	
Protection tube diameter	<ul style="list-style-type: none"> ■ 3 mm [0.12 in] ■ 6 mm [0.24 in] ■ 8 mm [0.31 in]
Insertion length U ₁	<ul style="list-style-type: none"> ■ 50 mm [1.97 in] ■ 75 mm [2.95 in] ¹⁾ ■ 100 mm [3.94 in] ¹⁾ ■ 120 mm [4.72 in] ¹⁾ ■ 150 mm [5.91 in] ¹⁾ ■ 200 mm [7.87 in] ¹⁾ ■ 250 mm [9.84 in] ¹⁾ ■ 300 mm [11.81 in] ¹⁾ ■ 350 mm [13.78 in] ¹⁾ ■ 400 mm [15.75 in] ¹⁾ <p>Other insertion lengths on request</p>
Material (wetted)	Stainless steel 1.4571

1) Not for protection tube diameter 3 mm [0.12 in]

If the resistance thermometer is to be operated in an additional protection tube, a spring-loaded compression fitting must be used.

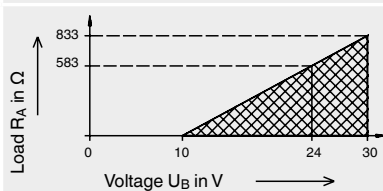
Output signal (4 ... 20 mA version)	
Analogue output	4 ... 20 mA, 2-wire
Load R_A	$R_A \leq (U_B - 10 \text{ V}) / 23 \text{ mA}$ with R _A in Ω and U _B in V The permissible load depends on the loop supply voltage.
Load diagram	

Output signal (4 ... 20 mA version)	
Factory configuration	
Measuring range	Measuring range 0 ... 150 °C [32 ... 302 °F] Other measuring ranges are adjustable
Current signals for error signalling	Configurable in accordance with NAMUR NE 043 downscale < 3.6 mA (3.5 mA) upscale > 21.0 mA (21.5 mA)
Current value for sensor short-circuit	Not configurable in accordance with NAMUR NE 043 downscale ≤ 3.6 mA (3.5 mA)
Communication	
Info data	TAG no., description and user message can be stored in transmitter
Configuration and calibration data	Permanently stored
Configuration software	WIKAsoft-TT → Configuration software (multilingual) as a download from www.wika.com
Voltage supply	
Supply voltage U_B	DC 10 ... 30 V
Supply voltage input	Protected against reverse polarity
Permissible residual ripple of supply voltage	10 % generated by U_B < 3 % ripple of the output current
Time response	
Switch-on delay, electrical	Max. 4 s (time before the first measured value)
Warm-up time	After approx. 4 minutes, the instrument will function to the specifications (accuracy) given in the data sheet.

Electrical connection	
Connection type	Angular connector DIN EN 175301-803 form A for cables with 6 ... 8 mm [0.24 ... 0.31 in] diameter, cross-section max. 1.5 mm ²
Material	
Case material of the connector	PA
Flat gasket	VMQ

Pin assignment

Output signal 4 ... 20 mA

Angular connector DIN EN 175301-803

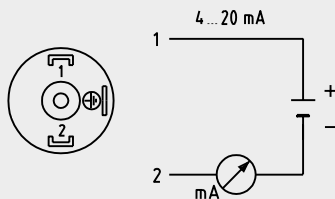

With direct sensor output

Angular connector DIN EN 175301-803

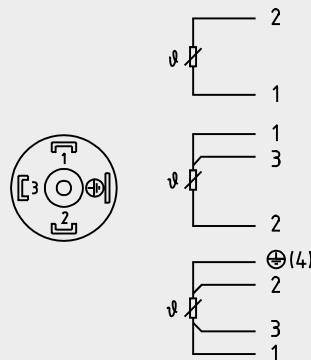

Operating conditions	
Ambient temperature range	-40 ... +85 °C [-40 ... +185 °F]
Storage temperature range	-40 ... +85 °C [-40 ... +185 °F]
Climate class per IEC 60654-1	Cx (-40 ... +85 °C [-40 ... +185 °F], 5 ... 95 % r. h.)
Maximum permissible humidity, condensation	100 % r. h., condensation allowed
Maximum operating pressure ^{1) 2)}	
For protection tube diameter 3 mm [0.12 in]	140 bar [2,030 psi]
For protection tube diameter 6 mm [0.24 in]	270 bar [3,916 psi]
For protection tube diameter 8 mm [0.31 in]	400 bar [5,801 psi]
Salt fog	IEC 60068-2-11
Vibration resistance per IEC 60751	10 ... 2,000 Hz, 8 g ¹⁾
Shock resistance per IEC 60068-2-27	50 g, 6 ms, 3 axes, 3 directions, three times per direction
Ingress protection (IP code)	IP65 per IEC/EN 60529
	The stated ingress protection only applies when plugged in using line connectors that have the appropriate ingress protection.
Weight	Approx. 0.2 ... 0.7 kg [0.44 ... 1.54 lbs] - depending on version

1) Dependent on the instrument version

2) Reduced operating pressure when using a compression fitting: Stainless steel = max. 100 bar [1,450 psi] / PTFE = max. 8 bar [116 psi]

Approvals

Logo	Description	Region
CE	EU declaration of conformity	European Union
	EMC directive ¹⁾	
	DIN EN 55011 (CISPR11): Emission (group 1, class B) DIN EN 61326-1, DIN EN 61326-2-3: immunity (industrial application)	
	RoHS directive	

1) During transient interferences (e.g. burst, surge, ESD) take into account an increased measuring deviation of up to 2.5 %.

Certificates (option)

Certification type	Measurement accuracy	Material certificate
2.2 test report	x	x
3.1 inspection certificate	x	x
DAkkS calibration certificate	x	-

The different certifications can be combined with each other.

For calibration, the measuring insert is removed from the thermometer. The minimum length (metal part of the probe) for carrying out a 3.1 measurement accuracy test or DAkkS is 100 mm [3.94 in].

Calibration of shorter lengths on request.

→ Approvals and certificates, see website

Dimensions in mm [in]

Process connection with parallel threads (or without process connection)

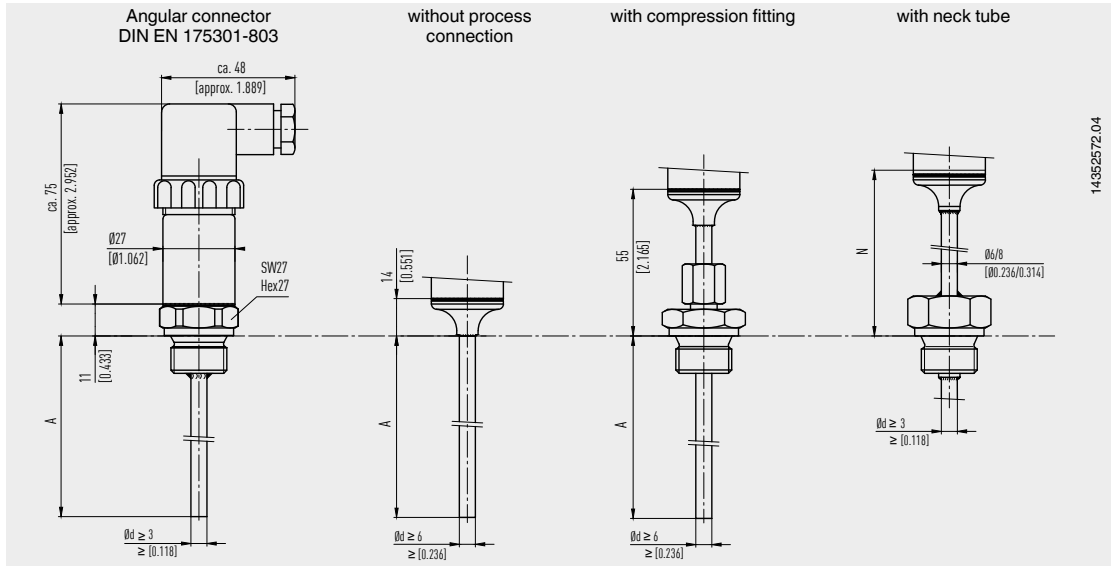

Process connection with tapered thread

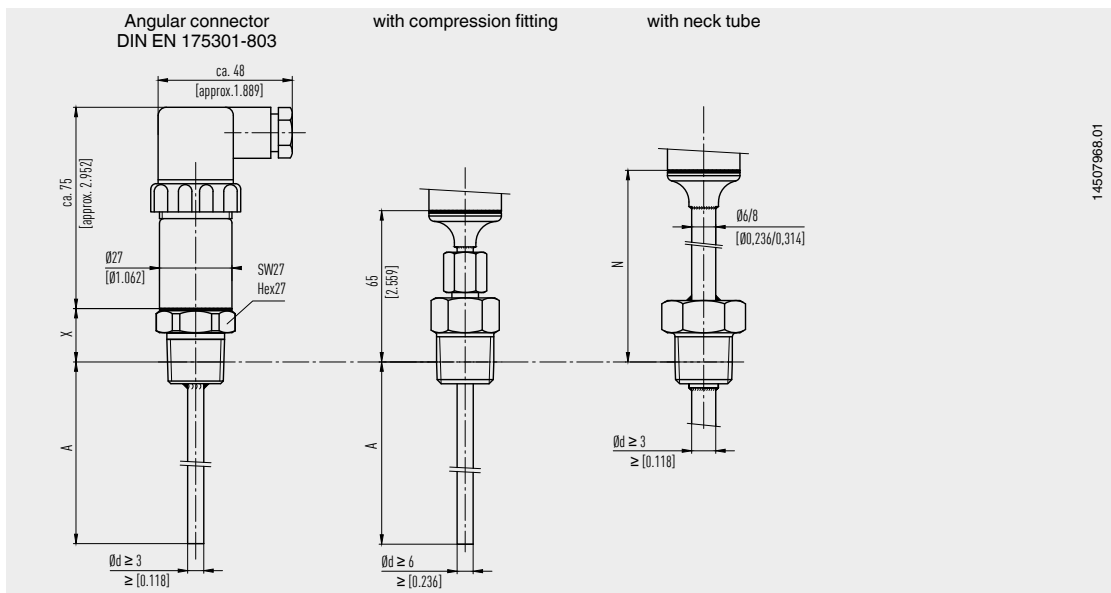

At a process temperature of > 150 °C [302 °F], a neck tube length N of 70 mm [2.76 in] is necessary.

Legend:

- A Insertion length
- N Neck tube length (70 mm [2.76 in])
- Ød Protection tube diameter
- X Height process connection
1/4 NPT = 15 mm [0.59 in]
1/2 NPT = 19 mm [0.75 in]

Connecting the PU-548 programming unit

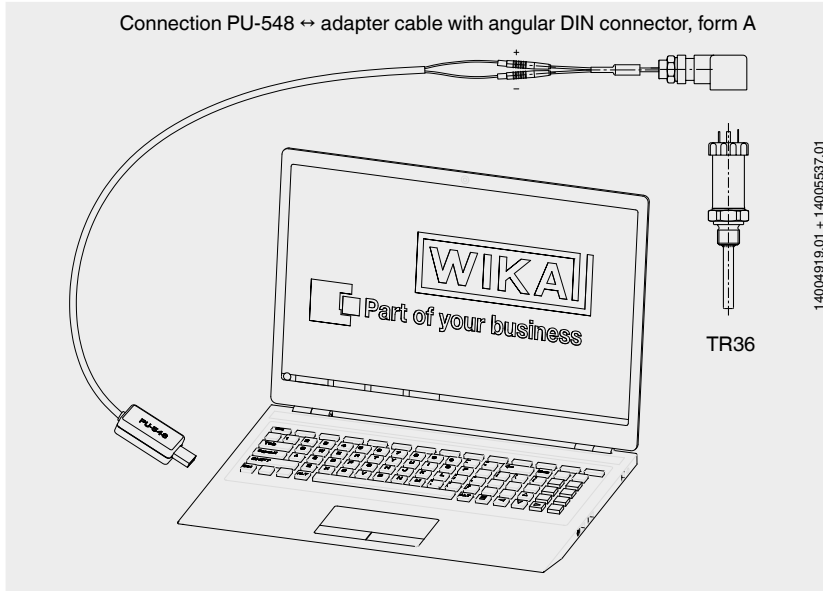

(predecessor, programming unit model PU-448, also compatible)

Accessories

Model	Description	Order number
 Programming unit Model PU-548	<ul style="list-style-type: none"> ■ Easy to use ■ LED status display ■ Compact design ■ No further voltage supply needed, neither for the programming unit nor for the transmitter <p>(replaces programming unit model PU-448)</p>	14231581
-	Adapter cable DIN angular connector to PU-548 Adapter cable DIN angular connector for the connection of a resistance thermometer with a DIN EN 175301-803 angular connector form A to the model PU-548 programming unit	14005324

Ordering information

Model / Output signal / Transmitter temperature unit / Process temperature / Transmitter initial value / Transmitter end value / Process connection / Protection tube diameter / Insertion length A (U₁) or A (U₂) / Neck length N (M_H) / Accessories / Certificates

© 08/2021 WIKA Alexander Wiegand SE & Co. KG, all rights reserved.
 The specifications given in this document represent the state of engineering at the time of publishing.
 We reserve the right to make modifications to the specifications and materials.

02/2022 EN

WIKA data sheet TE 60.36 · 02/2022

Page 7 of 7



WIKAI Alexander Wiegand SE & Co. KG
 Alexander-Wiegand-Straße 30
 63911 Klingenberg/Germany
 Tel. +49 9372 132-0
 Fax +49 9372 132-406
 info@wika.de
 www.wika.de

Operating limits and tolerances of platinum resistance thermometers per DIN EN IEC 60751

WIKA data sheet IN 00.17

General information

Temperature is a measurement for the thermal state of a material - so a measurement of the average kinetic energy of its molecules. A close thermal contact between two bodies is needed in order that these bodies adopt the same temperature (temperature equalisation). The body to be measured should be coupled as closely as possible to the temperature sensor system.

The most established temperature measurement methods are based on material or body properties that change depending on the temperature. One of the most-used methods is the measurement with a resistance thermometer.

This document outlines the recurrent concepts and technologies that apply to all resistance thermometers produced by WIKA.

Standard version

If there are no additional specifications or customer requirements, we will recommend this selection, or we will select this option when offering or producing the thermometer.

Sensor technology

The electrical resistance of a resistance thermometer's sensor changes with the temperature. As the resistance increases when temperature is raised, we refer to it as PTC (Positive Temperature Coefficient).

Pt100 or Pt1000 measuring resistors are normally used for industrial applications. The exact characteristics of these measuring resistors, and the thermometers based on them, are defined in IEC 60751. The most important characteristics are described in this document.

Resistance basic values at 0 °C

Designation	Basic value in Ω
Pt100	100
Pt1000	1,000

Bold: Standard version

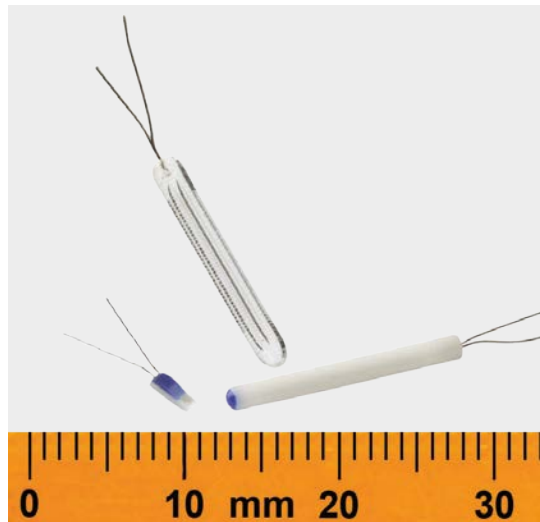

Fig. left: Thin-film measuring resistor

Fig. centre: Glass measuring resistor

Fig. right: Ceramic measuring resistor

Measuring resistor designs

Those measuring resistors used in thermometers can be wire-wound measuring resistors (W = Wire-Wound) or thin-film resistors (F = Thin-Film).

Thin-film measuring resistors (F), standard version

For thin-film measuring resistors, a very thin platinum film is applied to a ceramic carrier plate. Then, connecting wires are attached. Finally, the platinum film and the connecting wire connection are sealed against external effects by a layer of glass.

The thin-film measuring resistor is characterised by

- Temperature range: -50 ... +500 °C ¹⁾
- High vibration resistance
- Very small size
- Good price/performance ratio

Thin-film measuring resistors are the standard design unless the temperature range or an explicit customer request exclude them.

Thin-film measuring resistor

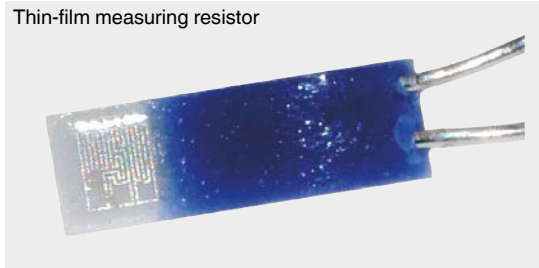

Wire-wound measuring resistors (W)

In this design, a very thin platinum wire is encased within a round protective body. This design has been well-established for decades and is accepted worldwide.

Two subtypes are available that differ in the choice of insulating material.

■ Glass measuring resistor

The bifilar wire of the glass measuring resistor is fused within a glass body.

The glass measuring resistor is characterised by:

- Temperature range: -196 ... +400 °C ¹⁾
- High vibration resistance

Glass measuring resistor



■ Ceramic measuring resistor

The platinum wire of a ceramic measuring resistor is spiral-wound and located in a cylindrical cavity in the protective body.

The ceramic measuring resistor is characterised by:

- Temperature range: -196 ... +600 °C ¹⁾
- Limited vibration resistance

Ceramic measuring resistor

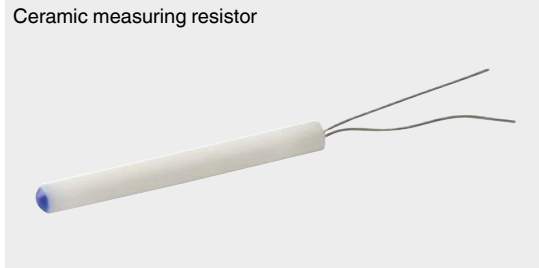

¹⁾ The specifications apply to class B, see also table on page 4

Sensor connection methods

■ 2-wire connection

The lead resistance to the sensor is recorded as an error in the measurement. For this reason, this connection type is not advisable when using Pt100 measuring resistors for tolerance classes A and AA, since the electrical resistance of the connecting cables and their own temperature dependency are fully included in the measuring result and thus falsify it.

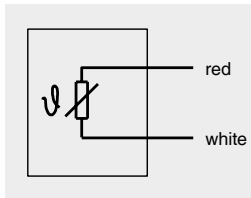

Applications

- Connecting cables up to 250 mm
- Standard when using Pt1000 measuring resistors

■ 3-wire connection (standard version)

The influence of the lead resistance is compensated as far as possible. The maximum length of the connecting cable depends on the conductor cross-section and the compensation options of the evaluation electronics (transmitter, display, controller or process control system).

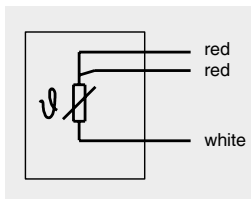

Applications

- Connecting cables up to approx. 30 m

■ 4-wire connection

The influence of the connecting cable on the measuring result is completely eliminated since any possible asymmetries in the connecting cable's lead resistance are also compensated.

The maximum length of the connecting cable depends on the conductor cross-section and the compensation options of the evaluation electronics (transmitter, display, controller or process control system). A 4-wire connection can also be used as a 2-wire or 3-wire connection by disconnecting the unnecessary conductors.

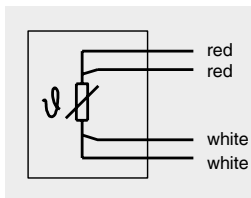

Applications

- Laboratory technology
- Calibration technology
- Tolerance class A or AA
- Connecting cables up to 1,000 m

Dual sensors

In the standard version a single sensor is fitted.

The combination of black and yellow is reserved for an optional second measuring resistor. For certain combinations (e.g. small diameter) dual sensors are not possible for technical reasons.

Relationship between temperature and resistance

For each temperature there is exactly one resistance value.
This clear relationship can be described by mathematical formulae.

For the temperature range -200 ... 0 °C the following applies, irrespective of the resistor design:

$$R_t = R_0 [1 + At + Bt^2 + C(t - 100 \text{ °C}) \cdot t^3]$$

For the temperature range 0 ... 600 °C the following applies:

$$R_t = R_0 [1 + At + Bt^2]$$

Legend:

t = Temperature in °C
R_t = Resistance in ohms at the measured temperature
R₀ = Resistance in ohms at t = 0 °C (e.g. 100 ohms)

For the calculation, the following constants apply

$$A = 3.9083 \cdot 10^{-3} \text{ (°C}^{-1}\text{)}$$

$$B = -5.7750 \cdot 10^{-7} \text{ (°C}^{-2}\text{)}$$

$$C = -4.1830 \cdot 10^{-12} \text{ (°C}^{-4}\text{)}$$

Operating limits and tolerance classes

Both measuring resistor versions (wire-wound/thin-film) differ in the possible tolerances at the operating temperatures.

Class	Temperature range in °C		Tolerance value
	Wire-wound (W)	Thin-film (F)	
B	-196 ... +600	-50 ... +500	±(0.30 + 0.0050 t)¹⁾
A	-100 ... +450	-30 ... +300	±(0.15 + 0.0020 t) ¹⁾
AA	-50 ... +250	0 ... 150	±(0.10 + 0.0017 t) ¹⁾

1) | t | is the numerical value of the temperature in °C irrespective of the sign.

Bold: Standard version

Under certain conditions, thermometers/measuring inserts with built-in measuring resistors can be operated in a temperature range outside the temperature range of the specified class.

The following must be observed regarding the compliance with the tolerance class:

With standard instruments, the class A specified before can no longer be confirmed if the thermometer or measuring insert was operated above or below the class A temperature range. The dwell time is not relevant here.

Even if the temperature is in the range of class A again, the tolerance class of the measuring resistor is no longer defined.

Resistance values and tolerance values with selected temperatures (Pt100)

Tolerance value IEC 60751 for resistance thermometers with film measuring resistors

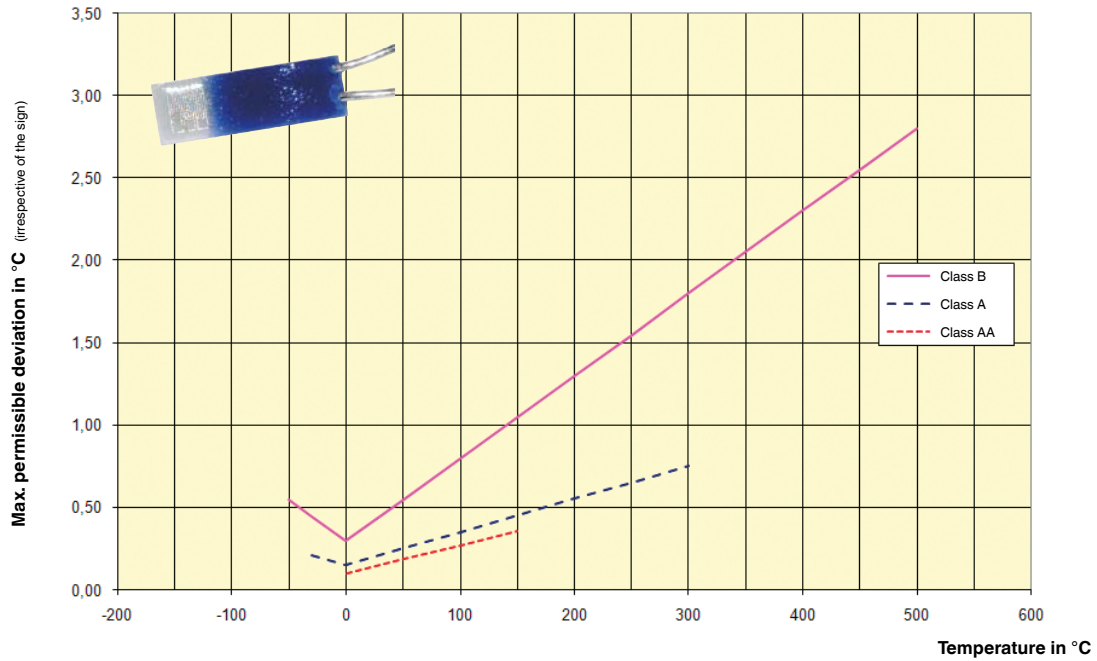

Tolerance value IEC 60751 for resistance thermometers with wire-wound measuring resistors

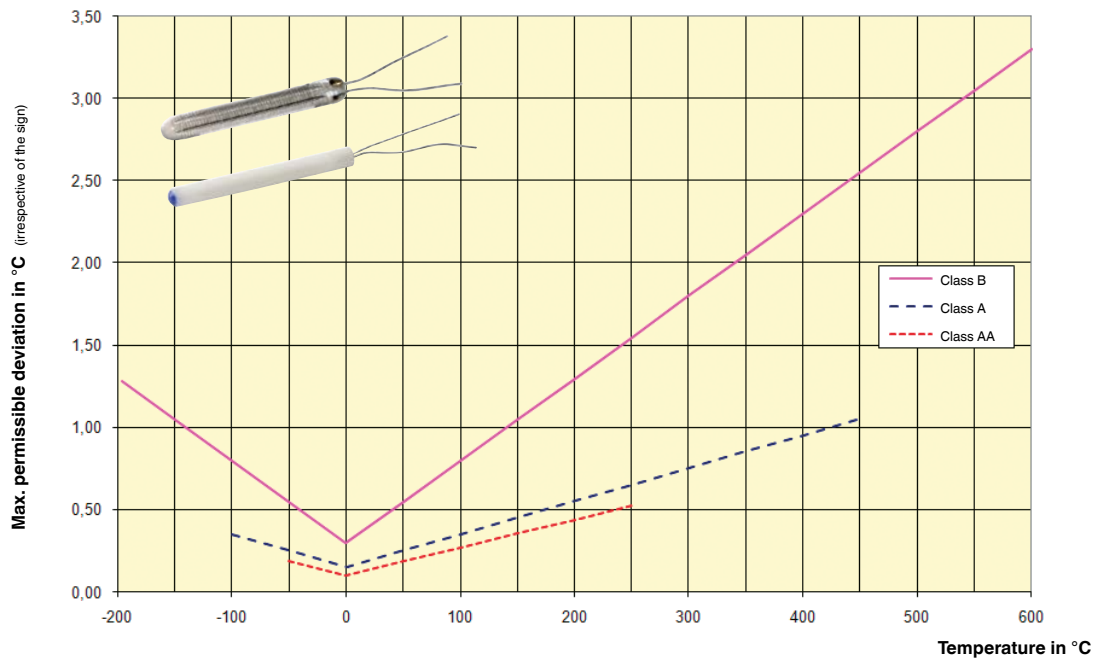

Temperature values and tolerance values with selected resistance values (Pt100)

Resistance value in Ω	Temperature value in $^{\circ}\text{C}$ (ITS 90)		
	Tolerance class B	Tolerance class A	Tolerance class AA
50	-126.07 ... -124.22	-125.55 ... -124.75	-125.46 ... -124.83
80	-51.32 ... -50.22	-51.02 ... -50.52	-50.96 ... -50.58
100	-0.30 ... +0.30	-0.15 ... +0.15	-0.10 ... +0.10
110	25.26 ... 26.11	25.48 ... 25.89	25.54 ... 25.83
150	129.50 ... 131.40	130.04 ... 130.86	130.13 ... 130.77
200	264.72 ... 267.98	265.67 ... 267.03	265.80 ... 266.90
300	554.60 ... 560.78	556.42 ... 558.95	556.64 ... 558.74

This table can be used to check the evaluation electronics, e.g. by means of a decade resistor:

This means if the sensor or the measuring resistor is simulated by a decade resistor, the evaluation electronics must display a temperature value within the limit values specified above.

Resistance values and tolerance values with selected temperatures (Pt100)

Temperature in $^{\circ}\text{C}$ (ITS 90)	Resistance value in Ω		
	Tolerance class B	Tolerance class A	Tolerance class AA
-196	19.69 ... 20.80	-	-
-100	59.93 ... 60.58	60.11 ... 60.40	-
-50	80.09 ... 80.52	80.21 ... 80.41	80.23 ... 80.38
-30	88.04 ... 88.40	88.14 ... 88.30	88.16 ... 88.28
0	99.88 ... 100.12	99.94 ... 100.06	99.96 ... 100.04
20	107.64 ... 107.95	107.72 ... 107.87	107.74 ... 107.85
100	138.20 ... 138.81	138.37 ... 138.64	138.40 ... 138.61
150	156.93 ... 157.72	157.16 ... 157.49	157.91 ... 157.64
250	193.54 ... 194.66	193.86 ... 194.33	193.91 ... 194.29
300	211.41 ... 212.69	211.78 ... 212.32	-
450	263.31 ... 265.04	263.82 ... 264.53	-
500	280.04 ... 281.91	-	-
600	312.65 ... 314.77	-	-

This table represents the calibration process with predefined temperatures.

This means if a temperature standard is available, the resistance value of the test item must lie within the limits specified above.

Vibration resistance of resistance thermometers

In accordance with IEC 60751, the design of a resistance thermometer can be influenced by vibration-induced accelerations that can be up to 3 g (30 m/s²) and occur in a frequency range from 10 ... 500 Hz.

The vibration resistance data listed in the data sheets of the electrical thermometers from WIKA refer to the "peak-to-peak" value.

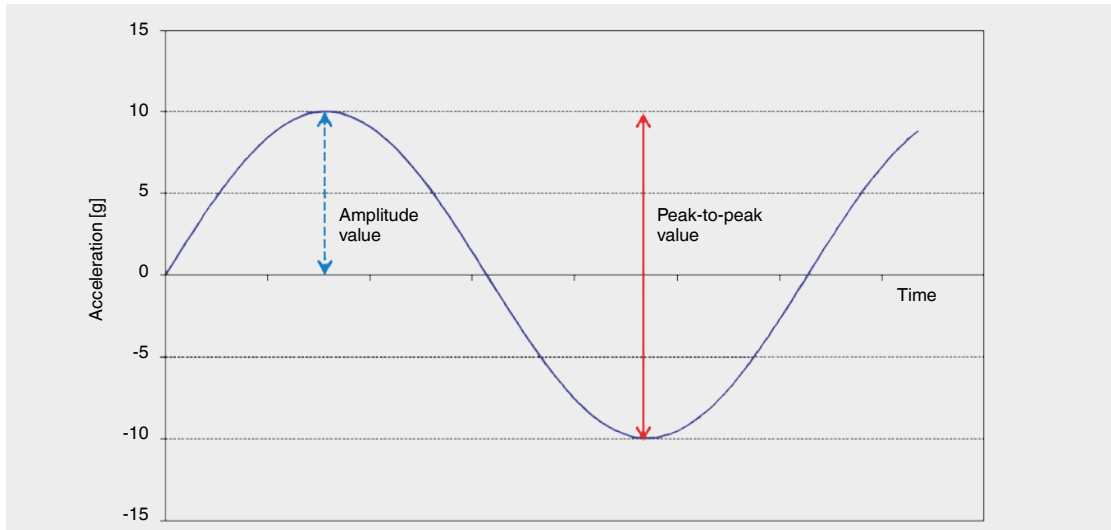

Version	Required vibration resistance per IEC 60751 in g ¹⁾ (peak-to-peak)	Determined vibration resistance WIKA per IEC 60751 in g ¹⁾ (peak-to-peak)
Standard	3	6
Vibration resistant (optional, thin-film measuring resistor)	-	20
Highly vibration resistant (special construction, thin-film measuring resistor)	-	50

1) 9.81 m/s²

Measuring resistor		Vibration resistance (peak-to-peak)					
		Ø 3 mm (MI cable)			Ø 6 mm (MI cable)		
		6 g	20 g	50 g	6 g	20 g	50 g
Thin-film (F)	1 x Pt100 / 1 x Pt1000	x	x	x	x	x	x
	2 x Pt100 / 2 x Pt1000	x	x	-	x	x	x
Thin-film, face-sensitive (FS)	1 x Pt100 / 1 x Pt1000	x	-	-	x	-	-
Wire-wound (W)	1 x Pt100 / 1 x Pt1000	x	-	-	x	-	-
	2 x Pt100 / 2 x Pt1000	x	-	-	x	-	-

The vibration resistance data listed in the data sheets of the electrical thermometers from WIKA only refer to the sensor tip.

© 01/2010 WIKA Alexander Wiegand SE & Co. KG, alle Rechte vorbehalten.
The specifications given in this document represent the state of engineering at the time of publishing.
We reserve the right to make modifications to the specifications and materials.

11/2020 EN

WIKA data sheet IN 00.17 · 11/2020

Page 8 of 8



WIKAL Alexander Wiegand SE & Co. KG
Alexander-Wiegand-Straße 30
63911 Klingenberg/Germany
Tel. +49 9372 132-0
Fax +49 9372 132-406
info@wika.de
www.wika.de