

Mini resistance thermometer

TR33 type



Art. No. 148315

Type No. TR33.100.3.A.12.100



Exemplary illustration

Resistance thermometer of these series are used as universal thermometers for the measurement of liquid and gaseous media. This resistance thermometer consists of a protection tube with a fixed process connection and is screwed directly into the process. All electrical components are protected against humidity and designed to withstand vibration.

Technical data

WIKA type	TR33
Housing	CrNi steel 1.4571
Indicating range	-30 to 150 °C
Ambient temperature	-40 to 85 °C
Protection IP	IP 67
Accuracy	class A
Output signal	Pt100, 3-wire
Installation length	100 mm
Thread	G 1/2 ET
Wetted parts	CrNi steel 1.4571
Electrical connection	circular plug-in connector M12x1

Other special versions with different insertion lengths, process connections, sensors and connection methods can be individually selected for the respective application and are available on request. The electrical connection is made via an M12x1 circular connector. An adapter for electrical connection with angular connector is optionally available.

Commercial data

Customs tariff number	90251900
Country of origin	PL
eCl@ss 5.1.4	27270101
eCl@ss 9.0	27270101
UNSPSC_Code_v190501	41112200
UNSPSC_CodeDesc_v190501	Temperature sensors

Miniature resistance thermometer Threaded Model TR33

WIKA data sheet TE 60.33



for further approvals
see page 6

Applications

- Machine building, plant and vessel construction
- Propulsion technology, hydraulics

Special features

- Very compact design, high vibration resistance and fast response time
- With direct sensor output (Pt100, Pt1000 in 2-, 3- or 4-wire connection) or integrated transmitter with 4 ... 20 mA output signal
- Integrated transmitter is individually parameterisable with free-of-charge WIKAsoft-TT PC configuration software
- Sensor element with accuracy class A per IEC 60751

Description

Resistance thermometers of these series are used as universal thermometers for the measurement of liquid and gaseous media in the range -50 ... +250 °C [-58 ... +482 °F].

They can be used for pressures up to 140 bar [2,030 psi] with 3 mm [0.12 in] protection tube diameters and up to 270 bar [3,916 psi] with 6 mm [0.24 in] protection tube diameters, depending on the instrument version. All electrical components are protected against humidity (IP67 or IP69K) and designed to withstand vibration (20 g, depending on instrument version).

The resistance thermometer is available with direct sensor output or integrated transmitter, which can be configured individually via the WIKAsoft-TT PC configuration software. Measuring range, dampening, error signalling per NAMUR NE 043 and tag no. can be adjusted.



Fig. left: Resistance thermometer, model TR33
Fig. right: M12 x 1 adapter to DIN EN 175301-803 angular connector

Insertion length, process connection, sensor and connection method can each be selected for the respective application within the ordering information. The model TR33 resistance thermometer consists of a protection tube with a fixed process connection and is screwed directly into the process. The electrical connection is made via an M12 x 1 circular connector. An adapter for electrical connection with angular connector per DIN EN 175301-803 is optionally available (patent, industrial property right: 001370985).

Specifications

Measuring element		
Type of measuring element		
Version 4 ... 20 mA (model TR33-Z-TT)	Pt1000 (measuring current < 0.3 mA; self-heating can be ignored)	
Version Pt100 (model TR33-Z-Px) / Pt1000 (model TR33-Z-Sx)	<ul style="list-style-type: none"> ■ Pt100 (measuring current: 0.1 ... 1.0 mA) ■ Pt1000 (measuring current: 0.1 ... 0.3 mA) 	
	→ For detailed specifications for Pt sensors, see Technical information IN 00.17 at www.wika.com .	
Connection method		
Version 4 ... 20 mA (model TR33-Z-TT)	2-wire	
Version Pt100 (model TR33-Z-Px) / Pt1000 (model TR33-Z-Sx)	2-wire	The lead resistance is recorded as an error in the measurement
	3-wire	With a cable length of 30 m or longer, measuring deviations can occur
	4-wire	The lead resistance can be ignored
Tolerance value of the measuring element ¹⁾ per IEC 60751		
Version 4 ... 20 mA (model TR33-Z-TT)	Class A	
Version Pt100 (model TR33-Z-Px) / Pt1000 (model TR33-Z-Sx)	<ul style="list-style-type: none"> ■ Class A ■ Class B at 2-wire 	

Accuracy specifications (4 ... 20 mA version)	
Tolerance value of the measuring element ¹⁾ per IEC 60751	Class A
Measuring deviation of the transmitter per IEC 62828	±0.25 K
Total measuring deviation per IEC 62828	Measuring deviation of the measuring element + transmitter
Influence of the ambient temperature	0.1 % of the set measuring span / 10 K T _a
Influence of supply voltage	±0.025 % / V (depending on the supply voltage U _B)
Influence of the load	±0.05 % / 100 Ω
Linearisation	Linear to temperature per IEC 60751
Output error	±0.1 % ²⁾
Reference conditions	
Ambient temperature T _a ref	23 °C
Supply voltage U _B ref	DC 12 V

1) Depending on the process connection, the deviation can be bigger.

2) ±0.2 % for start of measuring range less than 0 °C [32 °F]

Example calculation: Total measuring deviation

(measuring range 0 ... 150 °C, load 200 Ω, supply voltage 16 V, ambient temperature 33 °C, process temperature 100 °C)

Sensor element (class A per IEC 60751: 0.15 + (0.0020(t))):	±0.350 K
Measuring deviation of the transmitter ±0.25 K:	±0.250 K
Output error ±(0.1 % of 150 K):	±0.150 K
Influence of load ±(0.05 % / 100 Ω of 150 K):	±0.150 K
Influence of supply voltage ±(0.025 % / V of 150 K):	±0.150 K
Influence of the ambient temperature ±(0.1 % / 10 K T _a of 150 K):	±0.150 K

Measuring deviation (typical)

$$\text{sqrt}(0.35 \text{ K}^2 + 0.25 \text{ K}^2 + 0.15 \text{ K}^2 + 0.15 \text{ K}^2 + 0.15 \text{ K}^2)$$

$$\text{sqrt}(0.275 \text{ K}^2) = 0.524 \text{ K}$$

Measuring deviation (maximum)

$$0.35 \text{ K} + 0.25 \text{ K} + 0.15 \text{ K} + 0.15 \text{ K} + 0.15 \text{ K} + 0.15 \text{ K} = 1.2 \text{ K}$$

Measuring range	
Temperature range	
Version 4 ... 20 mA (model TR33-Z-TT)	Without neck tube -30 ... +150 °C [-22 ... +302 °F] With neck tube -30 ... +250 °C [-22 ... +482 °F] ¹⁾ Version with FKM O-ring: -20 ... +125 °C [-4 ... +257 °F]
Version Pt100 (model TR33-Z-Px) / Pt1000 (model TR33-Z-Sx)	Class A Without neck tube -30 ... +150 °C [-22 ... +302 °F] With neck tube -30 ... +250 °C [-22 ... +482 °F] Version with FKM O-ring: -20 ... +125 °C [-4 ... +257 °F] Class B Without neck tube -50 ... +150 °C [-58 ... +302 °F] With neck tube -50 ... +250 °C [-58 ... +482 °F]
Unit (4 ... 20 mA version)	Configurable °C, °F, K
Temperature at the connector (Pt100, Pt1000 version)	Max. 85 °C [185 °F]
Measuring span (4 ... 20 mA version)	Minimum 20 K, maximum 300 K

1) The temperature transmitter should therefore be protected from temperatures over 85 °C [185 °F].

Process connection	
Type of process connection	<ul style="list-style-type: none"> ■ G ¼ B ■ G ⅜ B ■ G ½ B ■ ¼ NPT ■ ½ NPT ■ M12 x 1.5 ■ M20 x 1.5 ■ 7/16-20 UNF-2A
Protection tube	
Protection tube diameter	<ul style="list-style-type: none"> ■ 3 mm [0.12 in] ■ 6 mm [0.24 in]
Insertion length U ₁	<ul style="list-style-type: none"> ■ 50 mm [1.97 in] ■ 75 mm [2.95 in] ¹⁾ ■ 100 mm [3.94 in] ¹⁾ ■ 120 mm [4.72 in] ¹⁾ ■ 150 mm [5.91 in] ¹⁾ ■ 200 mm [7.87 in] ¹⁾ ■ 250 mm [9.84 in] ¹⁾ ■ 300 mm [11.81 in] ¹⁾ ■ 350 mm [13.78 in] ¹⁾ ■ 400 mm [15.75 in] ¹⁾ Other insertion lengths on request
Material (wetted)	Stainless steel 1.4571

1) Not for protection tube diameter 3 mm [0.12 in]

If the resistance thermometer is to be operated in an additional protection tube, a spring-loaded compression fitting must be used.

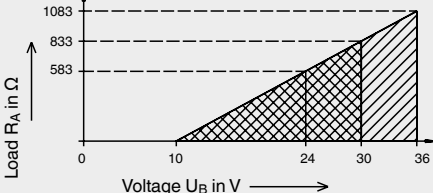
Output signal (4 ... 20 mA version)	
Analogue output	4 ... 20 mA, 2-wire
Load R_A	$R_A \leq (U_B - 10 \text{ V}) / 23 \text{ mA}$ with R_A in Ω and U_B in V The permissible load depends on the loop supply voltage. For communication with the instrument with programming unit PU-548, a max. load of 350 Ω is admissible.
Load diagram	
Factory configuration	
Measuring range	Measuring range 0 ... 150 °C [32 ... 302 °F] Other measuring ranges are adjustable
Current signals for error signalling	Configurable in accordance with NAMUR NE 043 downscale $\leq 3.6 \text{ mA}$ upscale $\geq 21.0 \text{ mA}$
Current value for sensor short-circuit	Not configurable in accordance with NAMUR NE 043 downscale $\leq 3.6 \text{ mA}$
Communication	
Info data	Tag no., description and user message can be stored in transmitter
Configuration and calibration data	Permanently stored
Configuration software	WIKAsoft-TT → Configuration software (multilingual) as a download from www.wika.com
Voltage supply	
Supply voltage U_B	DC 10 ... 30 V
Supply voltage input	Protected against reverse polarity
Permissible residual ripple of supply voltage	10 % generated by $U_B < 3 \%$ ripple of the output current
Time response	
Switch-on delay, electrical	Max. 4 s (time before the first measured value)
Warm-up time	After approx. 4 minutes, the instrument will function to the specifications (accuracy) given in the data sheet.

Electrical connection	
Connection type	M12 x 1 circular connector (4-pin)
Material	Stainless steel 1.4571

Pin assignment

Output signal 4 ... 20 mA
M12 x 1 circular connector (4-pin)

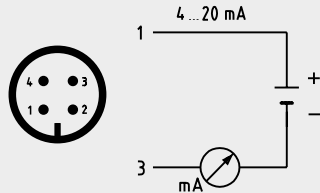

Pin	Signal	Description
1	L+	10 ... 30 V
2	VQ	not connected
3	L-	0 V
4	C	not connected

Output signal Pt100 or Pt1000 sensor
M12 x 1 circular connector (4-pin)

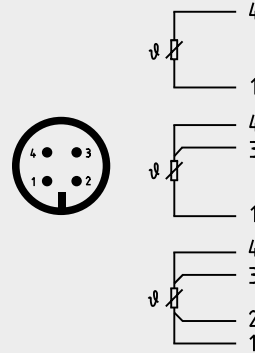

Operating conditions	
Ambient temperature range	
Version 4 ... 20 mA (model TR33-Z-TT)	-40 ... +85 °C [-40 ... +185 °F] Version with FKM O-ring: -20 °C [-4 °F]
Version Pt100 (model TR33-Z-Px) / Pt1000 (model TR33-Z-Sx)	-50 ... +85 °C [-58 ... +185 °F] Version with FKM O-ring: -20 °C [-4 °F]
Storage temperature range	
-40 ... +85 °C [-40 ... +185 °F] Version with FKM O-ring: -20 °C [-4 °F]	
Climate class per IEC 60654-1	
Version 4 ... 20 mA (model TR33-Z-TT)	Cx (-40 ... +85 °C [-40 ... +185 °F], 5 ... 95 % r. h.) Version with FKM O-ring: -20 °C [-4 °F]
Version Pt100 (model TR33-Z-Px) / Pt1000 (model TR33-Z-Sx)	Cx (-50 ... +85 °C [-58 ... +185 °F], 5 ... 95 % r. h.) Version with FKM O-ring: -20 °C [-4 °F]
Maximum permissible humidity, condensation	100 % r. h., condensation allowed
Maximum operating pressure ^{1) 2)}	
For protection tube diameter 3 mm [0.12 in]	140 bar [2,030 psi]
For protection tube diameter 6 mm [0.24 in]	270 bar [3,916 psi]
Salt fog	IEC 60068-2-11
Vibration resistance per IEC 60751	10 ... 2,000 Hz, 20 g ¹⁾
Shock resistance per IEC 60068-2-27	50 g, 6 ms, 3 axes, 3 directions, three times per direction
Maximum permissible autoclaving conditions	Max. 134 °C, 3 bar abs., 100 % r. h., duration 20 min., max. 50 cycles Autoclavable with mounted protective cap at coupler connector
Conditions for outdoor use (only applies to UL approval)	<ul style="list-style-type: none"> ■ The instrument is suitable for applications with pollution degree 3. ■ The power supply must be suitable for operation above 2,000 m should the temperature transmitter be used at this altitude. ■ The instrument shall be installed in locations sheltered from the weather. ■ The instrument shall be installed sun/UV irradiation protected.



Operating conditions	
Ingress protection (IP code)	
Case with connected connector ³⁾	<ul style="list-style-type: none"> ■ IP67 per IEC/EN 60529 ■ IP69 per IEC/EN 60529 ■ IP69K per ISO 20653 <p>The stated ingress protection only applies when plugged in using line connectors that have the appropriate ingress protection.</p>
Coupler connector, not connected	IP67 per IEC/EN 60529
Weight	approx. 0.2 ... 0.7 kg [0.44 ... 1.54 lbs] - depending on version

1) Dependent on the instrument version







2) Reduced operating pressure when using a compression fitting: Stainless steel = max. 100 bar [1,450 psi] / PTFE = max. 8 bar [116 psi]

3) Not tested with UL

Approvals

Logo	Description	Country
	EU declaration of conformity EMC directive ^{1) 2)} EN 61326 emission (group 1, class B) and immunity (industrial application) Configuration at 20 % of the full measuring range RoHS directive	European Union
	CSA Safety (e.g. electr. safety, overpressure, ...)	USA and Canada
	UL Safety (e.g. electr. safety, overpressure, ...)	USA and Canada

Optional approvals

Logo	Description	Country
	EAC EMC directive ¹⁾	Eurasian Economic Community
	GOST Metrology, measurement technology	Russia
	KazInMetr Metrology, measurement technology	Kazakhstan
-	MTSCHS Permission for commissioning	Kazakhstan
	BelGIM Metrology, measurement technology	Belarus
	UkrSEPRO Metrology, measurement technology	Ukraine
	Uzstandard Metrology, measurement technology	Uzbekistan

1) Only for built-in transmitter

2) During transient interferences (e.g. burst, surge, ESD) take into account an increased measuring deviation of up to 2 %.

Certificates (option)

Certification type	Measurement accuracy	Material certificate
2.2 test report	x	x
3.1 inspection certificate	x	x
DKD/DAkkS calibration certificate	x	-

The different certifications can be combined with each other.

For calibration, the measuring insert is removed from the thermometer. The minimum length (metal part of the probe) for carrying out a 3.1 measurement accuracy test or DKD/DAkkS is 100 mm [3.94 in].
Calibration of shorter lengths on request.

Approvals and certificates, see website

Patents, property rights

M12 x 1 adapter to DIN EN 175301-803 angular connector (001370985)

Dimensions in mm [in]

Process connection with parallel thread (or without process connection)

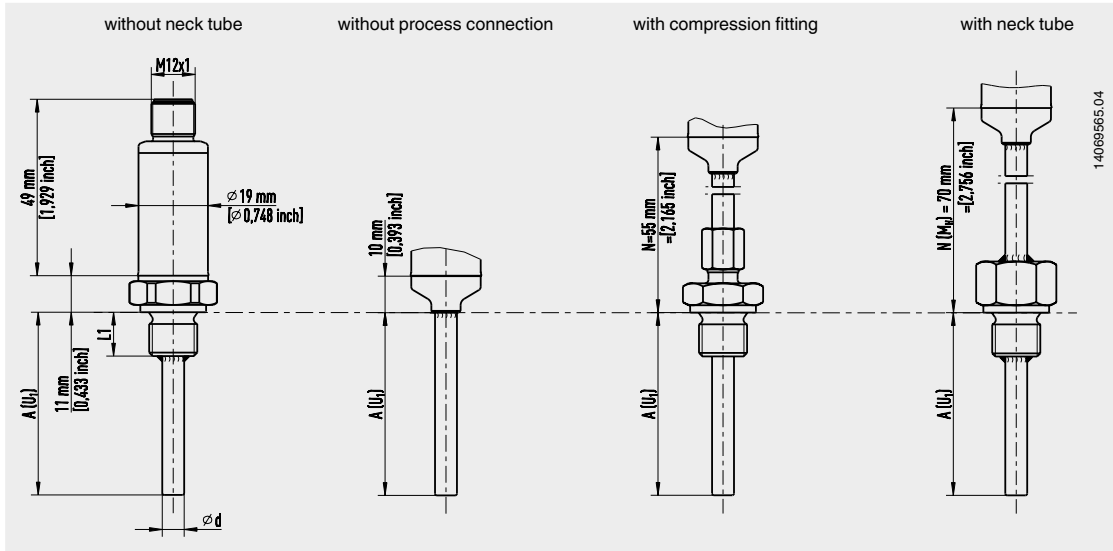

Process connection with parallel thread (7/16-20 UNF-2A) and O-ring

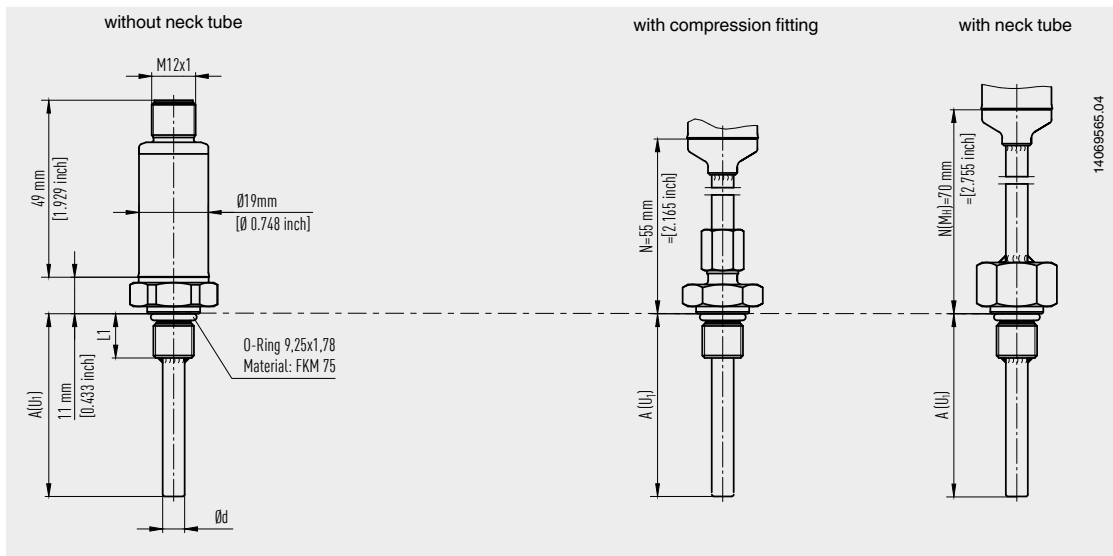

The FKM O-ring must be protected from temperatures lower than -20 °C [-4 °F] and higher than 125 °C [257 °F].

Process connection with tapered thread

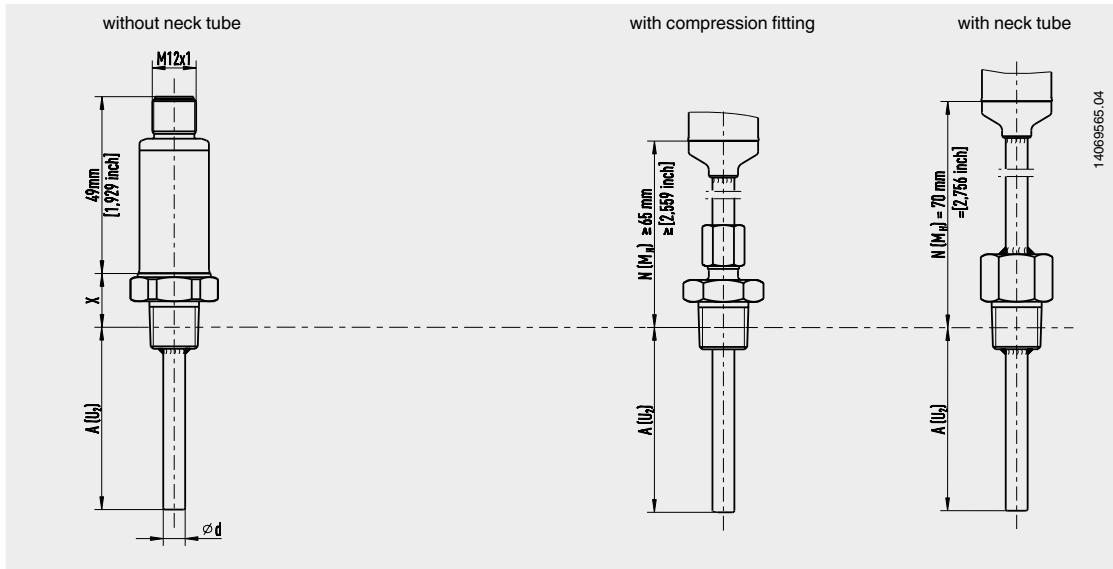

At a process temperature of > 150 °C [302 °F], a neck length N (M_H) of 70 mm [2.76 in] is necessary, otherwise N (M_H) selectable (55 mm [2.17 in], 65 mm [2.56 in] or 70 mm [2.76 in]).

Legend:

- | | | | |
|---------------------|------------------------------------|---------|---------------------------|
| A (U ₁) | Insertion length (parallel thread) | Ød | Protection tube diameter |
| A (U ₂) | Insertion length (tapered thread) | X | Height process connection |
| N (M _H) | Neck length | 1/4 NPT | = 15 mm [0.59 in] |
| | | 1/2 NPT | = 19 mm [0.75 in] |

Connecting the PU-548 programming unit

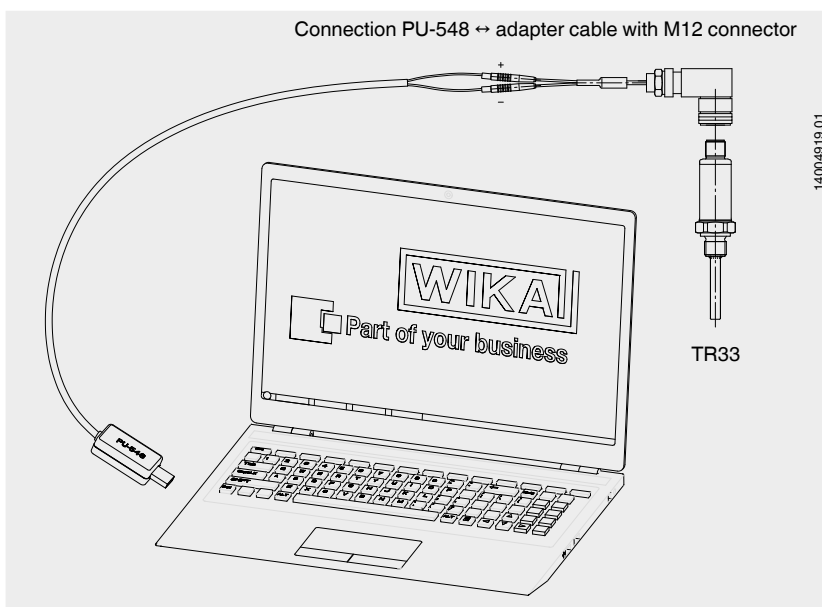

(predecessor, programming unit model PU-448, also compatible)

Accessories

Model	Description	Order no.
 Programming unit Model PU-548	<ul style="list-style-type: none"> ■ Easy to use ■ LED status display ■ Compact design ■ No further voltage supply needed, neither for the programming unit nor for the transmitter <p>(replaces programming unit model PU-448)</p>	14231581
 Adapter cable M12 to PU-548	Adapter cable for the connection of a model TR33 resistance thermometer to the model PU-548 programming unit	14003193
 M12 x 1 transmitter adapter to DIN EN 175301-803 angular connector (yellow female connector element)	Adapter for the connection of a resistance thermometer with a DIN EN 175301-803 angular connector form A with a 4 ... 20 mA output signal → see data sheet AC 80.17	14069503
	Case: PA Ambient temperature: -40 ... +115 °C [-40 ... +239 °F] Union nut: Zinc die-cast Contacts: Copper-zinc alloy, tinned Dielectric strength: 500 V Ingress protection: IP65	
	 <p>M12 x 1 connector Angular connector</p>	
 M12 x 1 Pt adapter to DIN EN 175301-803 angular connector (black female connector element)	Adapter for the connection of the resistance thermometer with a DIN EN 175301-803 form A angular connector with direct resistance output signal → see data sheet AC 80.17	14061115
	Case: PA Ambient temperature: -40 ... +115 °C [-40 ... +239 °F] Union nut: Zinc die-cast Contacts: Copper-zinc alloy, tinned Dielectric strength: 500 V Ingress protection: IP65	
	 <p>M12 x 1 connector Angular connector</p>	
 Angular connector	Per DIN EN 175301-803 form A	11427567
 Sealing for angular connector	For use with angular connector DIN EN 175301-803-A EPDM, brown	11437902

Model	Description	Order no.	
- M12 connection cable	Cable socket straight, 4-pin, ingress protection IP67 Temperature range -20 ... +80 °C [-4 ... +176 °F]	Cable length 2 m [6.56 ft]	14086880
		Cable length 5 m [16.40 ft]	14086883
	Cable socket straight, 4-pin, ingress protection IP69K, hygienic design Union nut from stainless steel Temperature range -40 ... +80 °C [-40 ... +176 °F]	Cable length 3 m [9.84 ft]	14137167
		Cable length 5 m [16.40 ft]	14137168
	Angled socket, 4-pin, ingress protection IP67 Temperature range -20 ... +80 °C [-4 ... +176 °F]	Cable length 2 m [6.56 ft]	14086889
		Cable length 5 m [16.40 ft]	14086891
	Angled socket, 4-pin, ingress protection IP69K, hygienic design Union nut from stainless steel Temperature range -40 ... +80 °C [-40 ... +176 °F]	Cable length 3 m [9.84 ft]	14137169
		Cable length 5 m [16.40 ft]	14137170
- M12 connector	Female angled, 4-pin, ingress protection IP67 Screw connection for conductor cross-section 0.25 ... 0.75 mm ² [24 ... 18 AWG] Cable gland Pg7, outside diameter of cable 4 ... 6 mm [0.16 ... 0.24 in] Temperature range -40 ... +80 °C [-40 ... +176 °F]	14136815	

Ordering information

Model / Output signal / Transmitter temperature unit / Process temperature / Transmitter initial value / Transmitter end value / Process connection / Protection tube diameter / Insertion length A (U₁) or A (U₂) / Neck length N (M_H) / Accessories / Certificates

© 04/2013 WIKA Alexander Wiegand SE & Co. KG, all rights reserved.
The specifications given in this document represent the state of engineering at the time of publishing.
We reserve the right to make modifications to the specifications and materials.

05/2021 DE

WIKA data sheet TE 60.33 · 05/2021

Page 11 of 11



WIKA Alexander Wiegand SE & Co. KG
Alexander-Wiegand-Straße 30
63911 Klingenberg/Germany
Tel. +49 9372 132-0
Fax +49 9372 132-406
info@wika.de
www.wika.de

Operating limits and tolerances of platinum resistance thermometers per DIN EN IEC 60751

WIKA data sheet IN 00.17

General information

Temperature is a measurement for the thermal state of a material - so a measurement of the average kinetic energy of its molecules. A close thermal contact between two bodies is needed in order that these bodies adopt the same temperature (temperature equalisation). The body to be measured should be coupled as closely as possible to the temperature sensor system.

The most established temperature measurement methods are based on material or body properties that change depending on the temperature. One of the most-used methods is the measurement with a resistance thermometer.

This document outlines the recurrent concepts and technologies that apply to all resistance thermometers produced by WIKA.

Standard version

If there are no additional specifications or customer requirements, we will recommend this selection, or we will select this option when offering or producing the thermometer.

Sensor technology

The electrical resistance of a resistance thermometer's sensor changes with the temperature. As the resistance increases when temperature is raised, we refer to it as PTC (Positive Temperature Coefficient).

Pt100 or Pt1000 measuring resistors are normally used for industrial applications. The exact characteristics of these measuring resistors, and the thermometers based on them, are defined in IEC 60751. The most important characteristics are described in this document.

Resistance basic values at 0 °C

Designation	Basic value in Ω
Pt100	100
Pt1000	1,000

Bold: Standard version

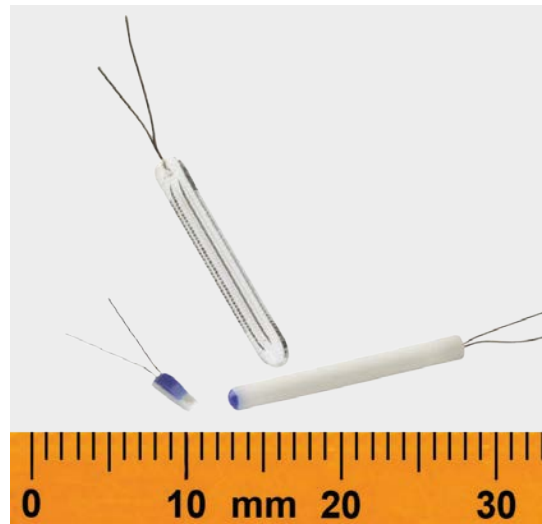

Fig. left: Thin-film measuring resistor

Fig. centre: Glass measuring resistor

Fig. right: Ceramic measuring resistor

Measuring resistor designs

Those measuring resistors used in thermometers can be wire-wound measuring resistors (W = Wire-Wound) or thin-film resistors (F = Thin-Film).

Thin-film measuring resistors (F), standard version

For thin-film measuring resistors, a very thin platinum film is applied to a ceramic carrier plate. Then, connecting wires are attached. Finally, the platinum film and the connecting wire connection are sealed against external effects by a layer of glass.

The thin-film measuring resistor is characterised by

- Temperature range: -50 ... +500 °C ¹⁾
- High vibration resistance
- Very small size
- Good price/performance ratio

Thin-film measuring resistors are the standard design unless the temperature range or an explicit customer request exclude them.

Thin-film measuring resistor

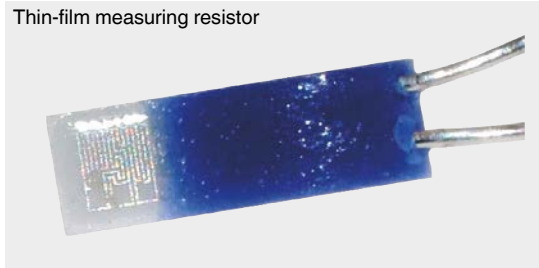

Wire-wound measuring resistors (W)

In this design, a very thin platinum wire is encased within a round protective body. This design has been well-established for decades and is accepted worldwide.

Two subtypes are available that differ in the choice of insulating material.

■ Glass measuring resistor

The bifilar wire of the glass measuring resistor is fused within a glass body.

The glass measuring resistor is characterised by:

- Temperature range: -196 ... +400 °C ¹⁾
- High vibration resistance

Glass measuring resistor

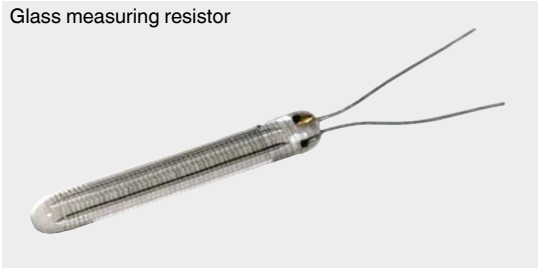

■ Ceramic measuring resistor

The platinum wire of a ceramic measuring resistor is spiral-wound and located in a cylindrical cavity in the protective body.

The ceramic measuring resistor is characterised by:

- Temperature range: -196 ... +600 °C ¹⁾
- Limited vibration resistance

Ceramic measuring resistor

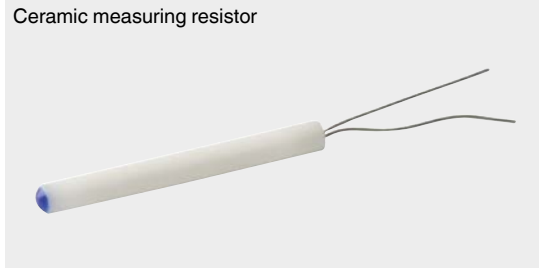

¹⁾ The specifications apply to class B, see also table on page 4

Sensor connection methods

■ 2-wire connection

The lead resistance to the sensor is recorded as an error in the measurement. For this reason, this connection type is not advisable when using Pt100 measuring resistors for tolerance classes A and AA, since the electrical resistance of the connecting cables and their own temperature dependency are fully included in the measuring result and thus falsify it.

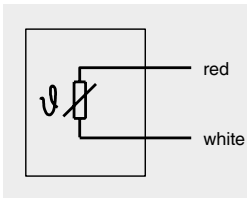

Applications

- Connecting cables up to 250 mm
- Standard when using Pt1000 measuring resistors

■ 3-wire connection (standard version)

The influence of the lead resistance is compensated as far as possible. The maximum length of the connecting cable depends on the conductor cross-section and the compensation options of the evaluation electronics (transmitter, display, controller or process control system).

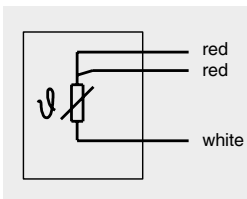

Applications

- Connecting cables up to approx. 30 m

■ 4-wire connection

The influence of the connecting cable on the measuring result is completely eliminated since any possible asymmetries in the connecting cable's lead resistance are also compensated.

The maximum length of the connecting cable depends on the conductor cross-section and the compensation options of the evaluation electronics (transmitter, display, controller or process control system). A 4-wire connection can also be used as a 2-wire or 3-wire connection by disconnecting the unnecessary conductors.

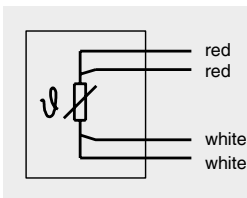

Applications

- Laboratory technology
- Calibration technology
- Tolerance class A or AA
- Connecting cables up to 1,000 m

Dual sensors

In the standard version a single sensor is fitted.

The combination of black and yellow is reserved for an optional second measuring resistor. For certain combinations (e.g. small diameter) dual sensors are not possible for technical reasons.

Relationship between temperature and resistance

For each temperature there is exactly one resistance value.
This clear relationship can be described by mathematical formulae.

For the temperature range -200 ... 0 °C the following applies, irrespective of the resistor design:

$$R_t = R_0 [1 + At + Bt^2 + C(t - 100 \text{ °C}) \cdot t^3]$$

For the temperature range 0 ... 600 °C the following applies:

$$R_t = R_0 [1 + At + Bt^2]$$

Legend:

t = Temperature in °C
R_t = Resistance in ohms at the measured temperature
R₀ = Resistance in ohms at t = 0 °C (e.g. 100 ohms)

For the calculation, the following constants apply

$$A = 3.9083 \cdot 10^{-3} \text{ (°C}^{-1}\text{)}$$

$$B = -5.7750 \cdot 10^{-7} \text{ (°C}^{-2}\text{)}$$

$$C = -4.1830 \cdot 10^{-12} \text{ (°C}^{-4}\text{)}$$

Operating limits and tolerance classes

Both measuring resistor versions (wire-wound/thin-film) differ in the possible tolerances at the operating temperatures.

Class	Temperature range in °C		Tolerance value
	Wire-wound (W)	Thin-film (F)	
B	-196 ... +600	-50 ... +500	±(0.30 + 0.0050 t)¹⁾
A	-100 ... +450	-30 ... +300	±(0.15 + 0.0020 t) ¹⁾
AA	-50 ... +250	0 ... 150	±(0.10 + 0.0017 t) ¹⁾

1) | t | is the numerical value of the temperature in °C irrespective of the sign.

Bold: Standard version

Under certain conditions, thermometers/measuring inserts with built-in measuring resistors can be operated in a temperature range outside the temperature range of the specified class.

The following must be observed regarding the compliance with the tolerance class:

With standard instruments, the class A specified before can no longer be confirmed if the thermometer or measuring insert was operated above or below the class A temperature range. The dwell time is not relevant here.

Even if the temperature is in the range of class A again, the tolerance class of the measuring resistor is no longer defined.

Resistance values and tolerance values with selected temperatures (Pt100)

Tolerance value IEC 60751 for resistance thermometers with film measuring resistors

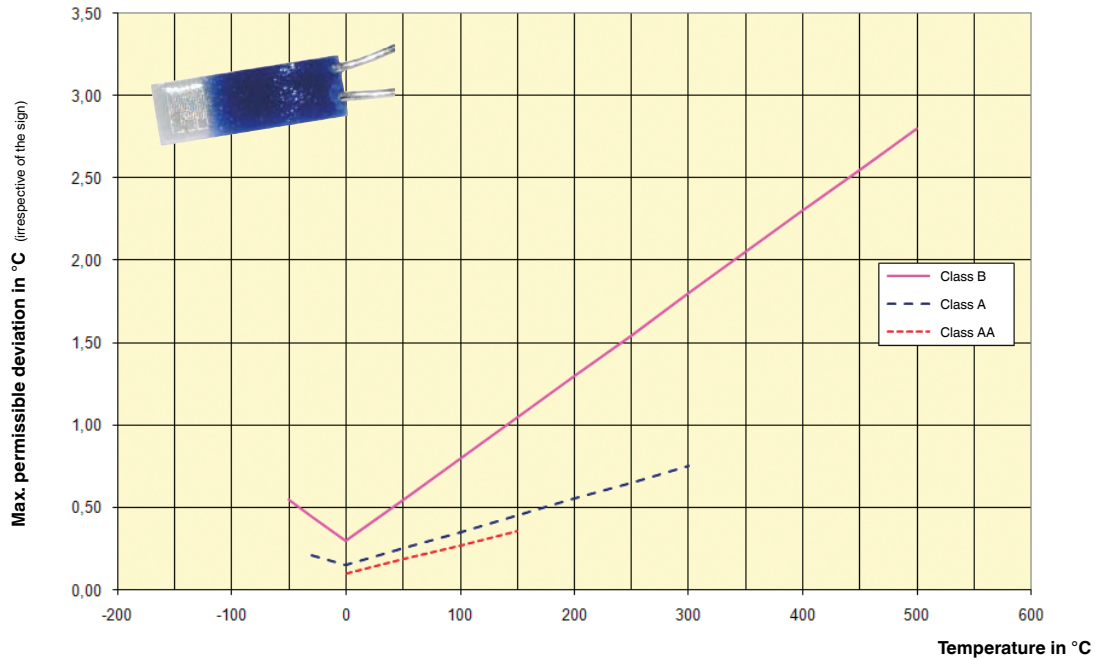

Tolerance value IEC 60751 for resistance thermometers with wire-wound measuring resistors

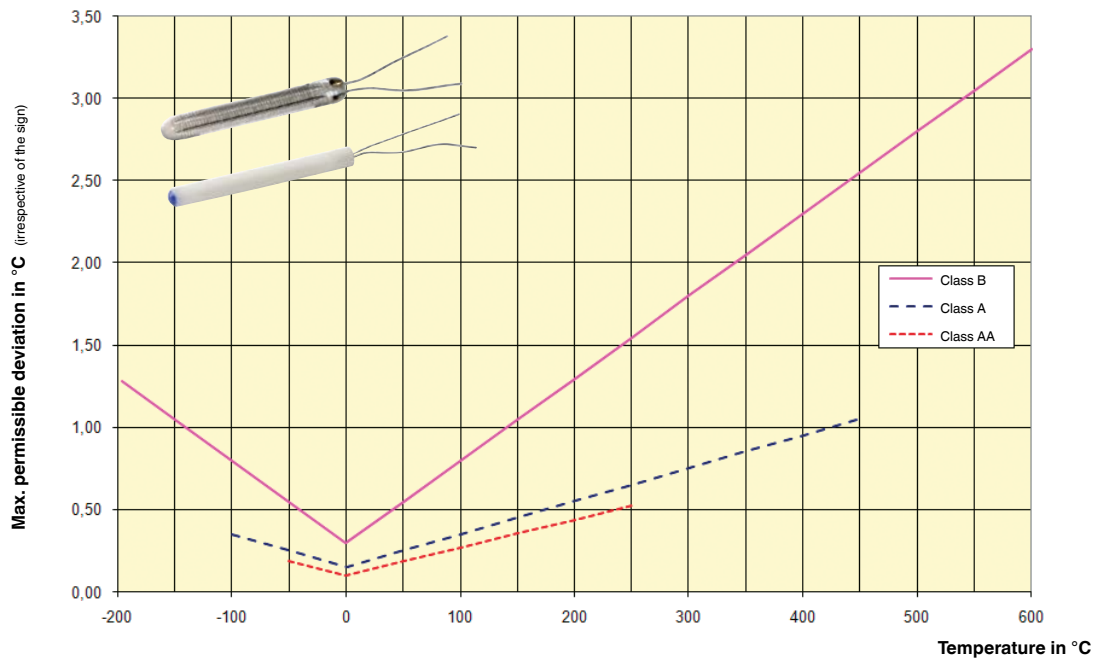

Temperature values and tolerance values with selected resistance values (Pt100)

Resistance value in Ω	Temperature value in $^{\circ}\text{C}$ (ITS 90)		
	Tolerance class B	Tolerance class A	Tolerance class AA
50	-126.07 ... -124.22	-125.55 ... -124.75	-125.46 ... -124.83
80	-51.32 ... -50.22	-51.02 ... -50.52	-50.96 ... -50.58
100	-0.30 ... +0.30	-0.15 ... +0.15	-0.10 ... +0.10
110	25.26 ... 26.11	25.48 ... 25.89	25.54 ... 25.83
150	129.50 ... 131.40	130.04 ... 130.86	130.13 ... 130.77
200	264.72 ... 267.98	265.67 ... 267.03	265.80 ... 266.90
300	554.60 ... 560.78	556.42 ... 558.95	556.64 ... 558.74

This table can be used to check the evaluation electronics, e.g. by means of a decade resistor:

This means if the sensor or the measuring resistor is simulated by a decade resistor, the evaluation electronics must display a temperature value within the limit values specified above.

Resistance values and tolerance values with selected temperatures (Pt100)

Temperature in $^{\circ}\text{C}$ (ITS 90)	Resistance value in Ω		
	Tolerance class B	Tolerance class A	Tolerance class AA
-196	19.69 ... 20.80	-	-
-100	59.93 ... 60.58	60.11 ... 60.40	-
-50	80.09 ... 80.52	80.21 ... 80.41	80.23 ... 80.38
-30	88.04 ... 88.40	88.14 ... 88.30	88.16 ... 88.28
0	99.88 ... 100.12	99.94 ... 100.06	99.96 ... 100.04
20	107.64 ... 107.95	107.72 ... 107.87	107.74 ... 107.85
100	138.20 ... 138.81	138.37 ... 138.64	138.40 ... 138.61
150	156.93 ... 157.72	157.16 ... 157.49	157.91 ... 157.64
250	193.54 ... 194.66	193.86 ... 194.33	193.91 ... 194.29
300	211.41 ... 212.69	211.78 ... 212.32	-
450	263.31 ... 265.04	263.82 ... 264.53	-
500	280.04 ... 281.91	-	-
600	312.65 ... 314.77	-	-

This table represents the calibration process with predefined temperatures.

This means if a temperature standard is available, the resistance value of the test item must lie within the limits specified above.

Vibration resistance of resistance thermometers

In accordance with IEC 60751, the design of a resistance thermometer can be influenced by vibration-induced accelerations that can be up to 3 g (30 m/s²) and occur in a frequency range from 10 ... 500 Hz.

The vibration resistance data listed in the data sheets of the electrical thermometers from WIKA refer to the "peak-to-peak" value.

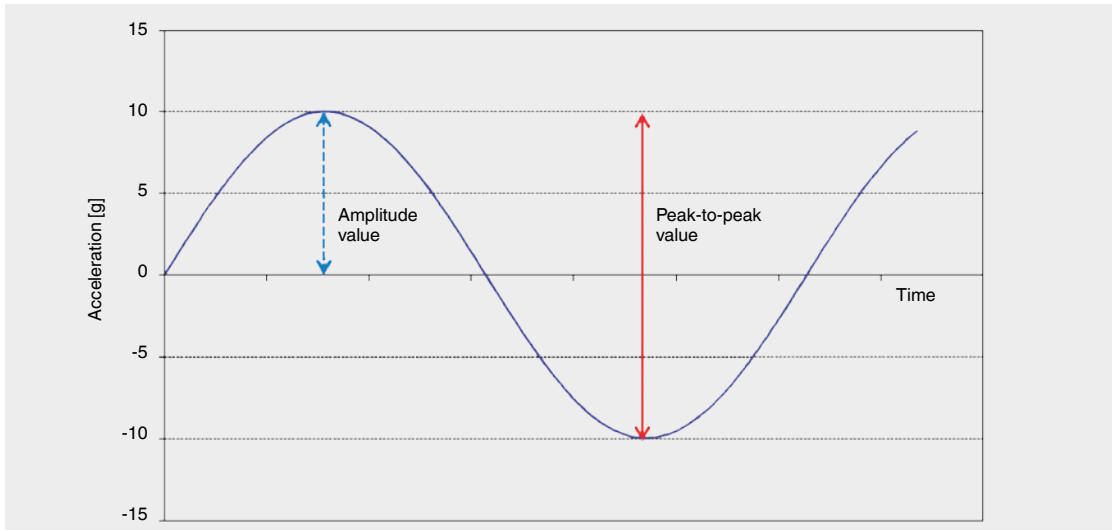

Version	Required vibration resistance per IEC 60751 in g ¹⁾ (peak-to-peak)	Determined vibration resistance WIKA per IEC 60751 in g ¹⁾ (peak-to-peak)
Standard	3	6
Vibration resistant (optional, thin-film measuring resistor)	-	20
Highly vibration resistant (special construction, thin-film measuring resistor)	-	50

1) 9.81 m/s²

Measuring resistor		Vibration resistance (peak-to-peak)					
		Ø 3 mm (MI cable)			Ø 6 mm (MI cable)		
		6 g	20 g	50 g	6 g	20 g	50 g
Thin-film (F)	1 x Pt100 / 1 x Pt1000	x	x	x	x	x	x
	2 x Pt100 / 2 x Pt1000	x	x	-	x	x	x
Thin-film, face-sensitive (FS)	1 x Pt100 / 1 x Pt1000	x	-	-	x	-	-
Wire-wound (W)	1 x Pt100 / 1 x Pt1000	x	-	-	x	-	-
	2 x Pt100 / 2 x Pt1000	x	-	-	x	-	-

The vibration resistance data listed in the data sheets of the electrical thermometers from WIKA only refer to the sensor tip.

© 01/2010 WIKA Alexander Wiegand SE & Co. KG, alle Rechte vorbehalten.
The specifications given in this document represent the state of engineering at the time of publishing.
We reserve the right to make modifications to the specifications and materials.

11/2020 EN

WIKA data sheet IN 00.17 · 11/2020

Page 8 of 8



WIKAL Alexander Wiegand SE & Co. KG
Alexander-Wiegand-Straße 30
63911 Klingenberg/Germany
Tel. +49 9372 132-0
Fax +49 9372 132-406
info@wika.de
www.wika.de

Accessories

	Art. No.	Type No.
Adapter M12 for resistance thermometer, 4 to 20 mA output signal, form A	148344	A.4-20.TR33
Adapter M12 for resistance thermometer, resistance output signal, form A	148345	A.W.TR33