

Pressure sensor

Typ A-1200



Art. No. 148295

Type No. A1200.14.040.1.1.P.IO.4



Exemplary illustration

The model A-1200 is a pressure sensor without display that can be flexibly programmed via IO link and used in a variety of ways. Thanks IO link, the model A-1200 pressure sensor is ideal for use in intelligent machines. To ensure precise measurement results over the long term, the pressure sensor has integrated diagnostic functions that monitor the instrument status and in addition, the model A-1200 can be configured externally and conveniently via the digital signal and adjusted at any time.

The robust version of the pressure sensor with IO link has been designed specifically for extreme environmental conditions. With welded M12x1 connector, this can easily withstand shock loads of up to 1000 g. It is designed for medium temperatures between -30 to 100 °C and can therefore be integrated into almost any application. Downtime and associated maintenance expenses and costs decrease significantly due to the stable design.

A 360° LED status display provides visual information about the sensor status. The green (OK), yellow (critical state) or red (error) signal enables intuitive and fast error detection and correction. For maintenance, a blinking function via IO link facilitates the clear localisation of a pressure sensor. Confusion is prevented and maintenance is accelerated.

Technical data

WIKA type	A-1200
Housing	CrNi steel 316L
Ambient temperature	-30 to 85 °C
Protection IP	IP65 and IP67
Accuracy	1.0 % FS
Output signal	1 switching output (PNP, IO link)
Thread	G 1/4 AG
Wetted parts	CrNi steel 316L, PH steel
Electrical connection	circular plug-in connector M12x1, 4-wire
IO-Link	1.1
Power supply	DC 10 - 32 V
Measuring range	0 to 40 bar
Operating temperature	-20 to 80 °C
Medium temperature	-30 to 100 °C

Other special versions with different output signals, measuring ranges, accuracy classes, process connections, pressure units and approvals can be individually selected for the respective application and are available on request.

Commercial data

Customs tariff number	90262020
Country of origin	DE
eCl@ss 5.1.4	27140101
eCl@ss 9.0	27140101
UNSPSC_Code_v190501	41112219
UNSPSC_CodeDesc_v190501	Electronic temperature switches

Pressure sensor with IO-Link PNP or NPN switching output Model A-1200

WIKA data sheet PE 81.90



Applications

- Machine tools
- Hydraulics and pneumatics
- Automation engineering
- Special-purpose machine building

Special features

- Industry 4.0-ready IO-Link sensor improves connectivity and diagnostics
- Designed for rough demands of up to 1,000 g shock and -40 ... +125 °C [-40 ... +257 °F]
- Optimised design makes OEM machine integration easier
- Multicolour 360° LED status display simplifies troubleshooting and localisation



Fig. left: Metal version

Fig. right: Version with three-coloured status display

Description

The model A-1200 is a pressure sensor without display that can be flexibly programmed via IO-Link and used in a variety of ways – whether for pressure monitoring or as an electronic PNP/NPN switch for process control.

More safety through digital connectivity

Thanks to IO-Link, the model A-1200 pressure sensor is ideal for use in intelligent machines. To ensure precise measurement results over the long term, the pressure sensor has integrated diagnostic functions that monitor the instrument status. In addition, the model A-1200 can be configured externally and conveniently via the digital signal and adjusted at any time.

Robust and durable, even in harsh environments

The robust version of the model A-1200 has been designed specifically for extreme environmental conditions. With a welded M12 x 1 connector, this can easily withstand shock loads of up to 1,000 g. It is designed for medium

temperatures between -40 ... +125 °C and can therefore be integrated into almost any application. Downtime and associated maintenance expenses and costs decrease significantly due to the stable design.

Simple OEM integration

The integration of the model A-1200 pressure sensor into OEM series production is accomplished quickly. The sensors can be preset by WIKA based on the customer's desired parameters. Alternatively, automated IO-Link programming can shorten the configuration time in the factory.

Fast maintenance thanks to visual feedback

A 360° LED status display provides visual information about the sensor status. The green (OK), yellow (critical state) or red (error) signal enables intuitive and fast error detection and correction. For maintenance, a blinking function via IO-Link facilitates the clear localisation of a pressure sensor. Confusion is prevented and maintenance is accelerated.

Measuring ranges

Gauge pressure								
bar	0 ... 0.4	0 ... 0.6	0 ... 1	0 ... 1.6	0 ... 2.5	0 ... 4	0 ... 6	0 ... 10
	0 ... 16	0 ... 25	0 ... 40	0 ... 60	0 ... 100	0 ... 160	0 ... 250	0 ... 400
	0 ... 600	0 ... 1,000						
psi	0 ... 10	0 ... 15	0 ... 25	0 ... 30	0 ... 50	0 ... 100	0 ... 160	0 ... 200
	0 ... 300	0 ... 500	0 ... 1,000	0 ... 1,500	0 ... 2,000	0 ... 3,000	0 ... 5,000	0 ... 7,500
	0 ... 10,000	0 ... 15,000						

Absolute pressure								
bar	0 ... 0.4	0 ... 0.6	0 ... 1	0 ... 1.6	0 ... 2.5	0 ... 4	0 ... 6	0 ... 10
	0 ... 16	0 ... 25						
psi	0 ... 10	0 ... 15	0 ... 25	0 ... 30	0 ... 50	0 ... 100	0 ... 160	0 ... 200
	0 ... 300							

Vacuum and +/- measuring range								
bar	-1 ... 0	-1 ... +0.6	-1 ... +1.5	-1 ... +3	-1 ... +5	-1 ... +9	-1 ... +15	-1 ... +24
psi	-14.5 ... 0	-14.5 ... +15	-14.5 ... +30	-14.5 ... +50	-14.5 ... +100	-14.5 ... +160	-14.5 ... +200	-14.5 ... +300

The given measuring ranges are also available in kg/cm², kPa and MPa.

Special measuring ranges between 0 ... 0.4 and 0 ... 1,000 bar [0 ... 10 to 0 ... 15,000 psi] are available on request.

Special measuring ranges have a reduced long-term stability and higher temperature errors.

Overload safety

The overload safety is based on the sensor element used. Dependent on the selected process connection and the sealing, restrictions in overload safety can result.

- Measuring range ≤ 600 bar [$< 8,000$ psi]: 2 times
- Measuring range > 1,000 bar [$\geq 8,000$ psi]: 1.5 times

Increased overload safety (option)

With increased overload safety there are deviations in temperature error and long-term stability.

Vacuum-tight

Yes

LED status display (option)

Visibility: 360°
 Green: Operation
 Yellow: Warning
 Red: Error

Output signals

Switching output		IO-Link 1.1	Teach
SP1	SP2		
PNP	-	-	-
PNP	-	x	-
NPN	-	-	-
PNP	-	-	x
NPN	-	-	x
PNP	PNP	x	-
NPN	NPN	-	-

IO-Link

Revision: 1.1
 Transmission rate: 38.4 kBaud (COM2)
 Min. cycle time: 2.3 ms
 Master port class: A

Adjustment of zero point offset

max. 3 % of span (via IO-Link)

Damping of switching outputs

0 ms ... 65 s (adjustable via IO-Link)

Switch-on time

1 s

Switching thresholds

Switch point 1 and switch point 2 are individually adjustable via IO-Link.

Switch point 1 can be set to the prevailing pressure value using the teach function.

Switching functions

Normally open, normally closed, window, hysteresis (adjustable via IO-Link)

The switching function of switch point 1 can be set to normally closed or normally open using the teach function.

Switching voltage

Power supply - 1 V

Switching current

max. 250 mA, see derating curves

Response time of switching output

≤ 5 ms

Service life

100 million switching cycles

Derating curve per switching output, without UL approval

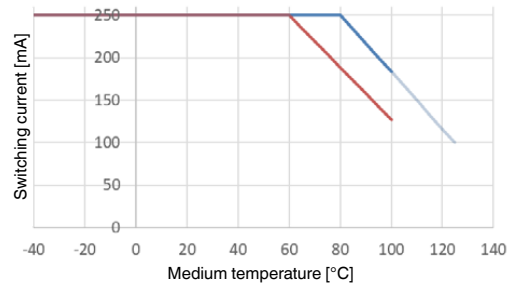

— Standard
 — Without IO-Link, Teach or LED indicator
 — With M12 x 1 circular connector, metallic

Derating curve per switching output, with UL approval

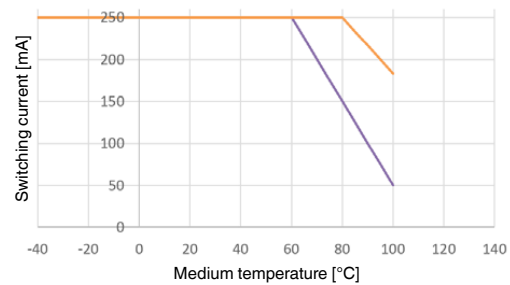

— Standard and IO-Link, Teach or LED indicator
 — With M12 x 1 circular connector, metallic

Voltage supply

Power supply

DC 10 ... 32 V

Current consumption

≤ 25 mA

Total current consumption

≤ 0.3 A incl. switching current (with one switching output)
 ≤ 0.6 A incl. switching current (with two switching outputs)

Reference conditions (per IEC 61298-1)

Temperature: 15 ... 25 °C [59 ... 77 °F]
 Atmospheric pressure: 860 ... 1,060 mbar [12.5 ... 15.4 psi]
 Air humidity: 45 ... 75 % r. h.
 Nominal position: Calibrated in vertical mounting position with process connection facing downwards.
 Power supply: DC 24 V

Accuracy specifications

Accuracy, switching output

≤ ±1 % of span (option: ≤ ±0.5 % of span)

Long-term drift, switching output

≤ ±0.1 %
 ≤ ±0.2 % for measuring ranges ≤ 0.69 bar [10 psi]
 ≤ ±0.26 % for increased overload safety

Switching current dependency

With switching currents greater than 50 mA:
 ≤ ±0.05 % per 50 mA additional applied switching current

Versions without teach function, LED status display and IO-Link 1.1:
 ≤ ±0.075 % per 50 mA additional applied switching current

Temperature error in rated temperature range

≤ ±1.5 % of span
 ≤ ±2.5 % of span for increased overload safety

Temperature coefficients in rated temperature range

Mean TC zero point: ≤ ±0.16 % of span/10 K
 Mean TC span: ≤ ±0.16 % of span/10 K

Operating conditions

Permissible temperature ranges

	Standard	Option 1) 2)
Medium	-30 ... +100 °C [-22 ... +212 °F]	-40 ... +125 °C [-40 ... +257 °F]
Ambient	-30 ... +85 °C [-22 ... +185 °F]	-40 ... +85 °C [-40 ... +185 °F]
Storage	-40 ... +70 °C [-40 ... +158 °F]	
Nominal temperature	-20 ... +80 °C [-4 ... +176 °F]	

1) Only for circular connector M12 x 1, metal

2) Medium temperature limited to -40 ... +100 °C [-40 ... +212 °F] with UL approval

Humidity

45 ... 75 % r. h.

Vibration resistance

25 g, 10 ... 2,000 Hz (IEC 60068-2-6, under resonance)

Shock resistance

100 g, 6 ms (IEC 60068-2-27, mechanical)
 1,000 g, 1 ms (IEC 60068-2-27, mechanical) 1)

1) Only for electrical connection, M12 x 1 metal

Service life

100 million load cycles

Ingress protection (per IEC 60529)

see "Electrical connections"

Mounting position

as required

Materials

Wetted parts

Measuring ranges < 10 bar [150 psi]: 316L
 Measuring ranges ≥ 10 bar [150 psi]: 316L, PH grade steel

Non-wetted parts

Case: 316L
 Circular connector M12 x 1, metal: 316L
 Circular connector M12 x 1: PBT GF30
 LED status display: PC

Pressure transmission medium

Synthetic oil for all gauge pressure measuring ranges < 10 bar [150 psi] ¹⁾ and all absolute pressure measuring ranges.

1) < 16 bar [250 psi] with increased overload safety

Options for specific media

- Oil and grease free: Residual hydrocarbon: < 1,000 mg/m²
- Oxygen, oil and grease free: Residual hydrocarbon: < 200 mg/m²

Packaging: Protection cap on the process connection, instrument sealed in a vacuum bag
 Max. permissible temperature -20 ... +60 °C [-4 ... +140 °F]
 Available measuring ranges:
 0 ... 0.4 bar to 0 ... 400 bar [0 ... 10 to 0 ... 5,000 psi]
 -1 ... 0 to -1 ... 24 bar [-14.5 ... 0 to -14.5 ... 300 psi]
 Factory supplied without sealing
 Available process connections, see "Process connections"

Process connections

Standard	Thread	Max. nominal pressure	Sealing
DIN EN ISO 1179-2 (formerly DIN 3852-E)	G ¼ A	600 bar [8,700 psi]	NBR (options: Without, FPM/FKM)
	G ½ A	400 bar [5,800 psi]	NBR (options: Without, FPM/FKM)
EN 837	G ¼ B ¹⁾	1,000 bar (14,500 psi)	without (options: Copper, stainless steel)
	G ¼ female ¹⁾	1,000 bar (14,500 psi)	without (options: Copper, stainless steel)
	G ½ B ¹⁾	1,000 bar (14,500 psi)	without (options: Copper, stainless steel)
ANSI/ASME B1.20.1	¼ NPT 1)	1,000 bar (14,500 psi)	-
	½ NPT 1)	1,000 bar (14,500 psi)	-
ISO 7	R ¼ 1)	1,000 bar (14,500 psi)	-
KS	PT ¼ 1)	1,000 bar (14,500 psi)	-
-	G ¼ female (Ermeto compatible)	1,000 bar (14,500 psi)	without (options: Copper, stainless steel)

1) suitable for oxygen, oil and grease free.

Other connections on request.

Restrictor (option)

For applications where pressure spikes can occur, the use of a restrictor is recommended. The restrictor narrows the pressure port to 0.6 mm and thus increases the resistance against pressure spikes.

Enlarged pressure port (option)

For applications with contaminated or viscous media, for specific process connections, an enlarged pressure port with a 6 or 12 mm diameter is available in order to reduce the risk of a pressure port blocking.

Electrical connections

Connection	Ingress protection (per IEC 60529)
Circular connector M12 x 1, metal (4-pin)	IP65 and IP67
Circular connector M12 x 1 (4-pin)	
with LED status display	IP65 and IP67
without LED status display	IP65 and IP67
Angular connector DIN 175301-803 A (3-pin) ¹⁾	
with LED status display	IP65
without LED status display	IP65

1) Only available without IO-Link and without teach function

The stated ingress protection (per IEC 60529) only applies when plugged in using mating connectors that have the appropriate ingress protection.

Electrical safety

Short-circuit resistance: SP1 / SP2 vs. U-
 Reverse polarity protection: U+ vs. U-
 Insulation voltage: DC 500 V
 Overvoltage protection: DC 36 V

Connection diagram

Circular connector M12 x 1 (4-pin)		
	U+	1
	U-	3
	SP1 / C	4
	SP2 / Teach	2

Angular connector DIN 175301-803 A (3-pin)		
	U+	1
	U-	2
	SP1	3

Legend:

U+ Positive power supply terminal
 U- Negative power supply terminal
 SP1 Switching output 1
 SP2 Switching output 2
 C Communication with IO-Link
 Teach Teach input for switching output/switching function

Dimensions in mm [in]

Circular connector M12 x 1 with LED status display

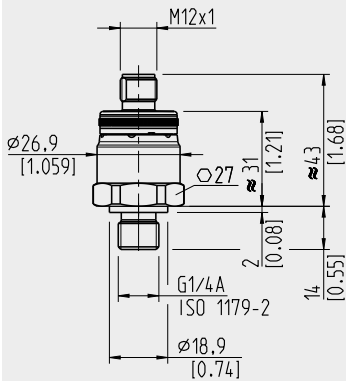

Weight: 60 ... 100 g [2.12 ... 3.53 oz]

Circular connector M12 x 1, metallic version

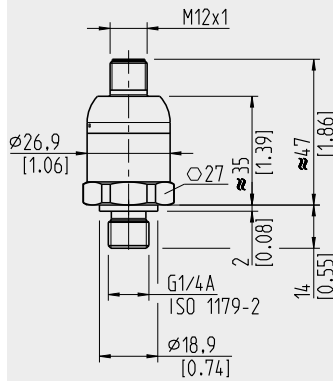

Weight: 80 ... 120 g [2.82 ... 4.23 oz]

Angular connector DIN 175301-803 A with LED status display

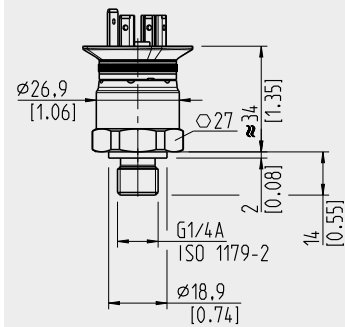

Weight: 60 ... 100 g [2.12 ... 3.53 oz]

DIN EN ISO 1179-2 (formerly DIN 3852-E)

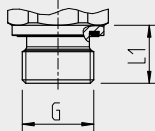

G	L1
G ¼ A	14 [0.55]
G ½ A	17 [0.67]

EN 837

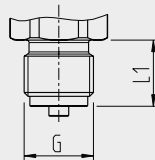

G	L1
G ¼ B	13 [0.51]
G ½ B	20 [0.79]

ANSI/ASME B1.20.1 KS ISO 7

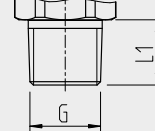

G	L1
¼ NPT	13 [0.51]
½ NPT	19 [0.75]
R ¼	13 [0.51]
PT ¼	13 [0.51]

Female thread

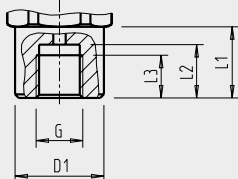

G	L1	L2	L3	D1
G ¼	20 [0.79]	15 [0.59]	12 [0.47]	Ø 25 [0.98]

Ermeto compatible

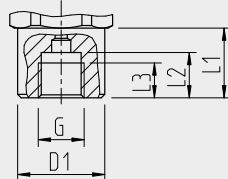

EN 837, female thread



G	L1	L2	L3	D1
G ¼ A	20 [0.79]	13 [0.51]	10 [0.39]	Ø 25 [0.98]





Accessories and spare parts

Sealings		
	Description	Order number
	NBR profile sealing G ¼ A DIN EN ISO 1179-2 (formerly DIN 3852-E)	1537857
	FPM/FKM profile sealing G ¼ A DIN EN ISO 1179-2 (formerly DIN 3852-E)	1576534
	NBR profile sealing G ½ A DIN EN ISO 1179-2 (formerly DIN 3852-E)	1039067
	FPM/FKM profile sealing G ½ A DIN EN ISO 1179-2 (formerly DIN 3852-E)	1039075
	Copper G ¼ B EN 837	11250810
	Stainless steel G ¼ B EN 837	11250844
	Copper G ½ B EN 837	11250861
	Stainless steel G ½ B EN 837	11251042

Connectors with moulded cable				
	Description	Temperature range	Cable diameter	Order number
	Straight version, cut to length, 4-pin, 2 m [6.6 ft] PUR cable, UL listed, IP67	-20 ... +80 °C [-4 ... +176 °F]	4.5 mm [0.18 in]	14086880
	Straight version, cut to length, 4-pin, 5 m [16.4 ft] PUR cable, UL listed, IP67	-20 ... +80 °C [-4 ... +176 °F]	4.5 mm [0.18 in]	14086883
	Straight version, cut to length, 4-pin, 10 m [32.8 ft] PUR cable, UL listed, IP67	-20 ... +80 °C [-4 ... +176 °F]	4.5 mm [0.18 in]	14086884
	Angled version, cut to length, 4-pin, 2 m [6.6 ft] PUR cable, UL listed, IP67	-20 ... +80 °C [-4 ... +176 °F]	4.5 mm [0.18 in]	14086889
	Angled version, cut to length, 4-pin, 5 m [16.4 ft] PUR cable, UL listed, IP67	-20 ... +80 °C [-4 ... +176 °F]	4.5 mm [0.18 in]	14086891
	Angled version, cut to length, 4-pin, 10 m [32.8 ft] PUR cable, UL listed, IP67	-20 ... +80 °C [-4 ... +176 °F]	4.5 mm [0.18 in]	14086892
	Connection cable, 4-pin, 2 m [6.6 ft] PUR cable, UL listed, IP67 1x LED green, 2x LED yellow	-20 ... +80 °C [-4 ... +176 °F]	4.5 mm [0.18 in]	14252834
	Connection cable, 4-pin, 5 m [16.4 ft] PUR cable, UL listed, IP67 1x LED green, 2x LED yellow	-20 ... +80 °C [-4 ... +176 °F]	4.5 mm [0.18 in]	14252835

IO-Link master		
	Description	Order number
	IO-Link master <ul style="list-style-type: none"> ■ USB port for setting, monitoring and diagnosing IO-Link instruments on notebook or desktop PC. ■ Connection of the IO-Link instruments via M12 x 1 circular connector ■ Licence for PC software (system requirement: Windows 7 / 8.1 and Windows 10 (32 or 64 bit)) ■ Suitable for IO-Link version V1.0 and V1.1 ■ 115/230 V AC - 24 V DC (1 A) external power supply and international adapter included ■ Instruments with a current requirement of up to 80 mA can be operated without external power, otherwise, the DC 24 V (1 A) external power supply must be connected. 	14239506

Approvals

Logo	Description	Country
	EU declaration of conformity <ul style="list-style-type: none"> ■ EMC directive, EN 61326 emission (group 1, class B) and immunity (industrial application) ■ Pressure equipment directive ■ RoHS directive 	European Union
	UL Safety (e.g. electr. safety, overpressure, ...)	USA and Canada
	EAC EMC directive	Eurasian Economic Community
	GOST Metrology, measurement technology	Russia

Manufacturer's information and certificates

Logo	Description
-	China RoHS directive
-	MTTF > 100 years

Patents, property rights

Protected design (DPMA (German patent and trade mark office) no. 402017001481-0003)

Approvals and certificates, see website

Ordering information

Model / Accuracy / Measuring range / Process connection / Sealing / Medium temperature / Output signal / Electrical connection / Options for special media and overload safety

© 04/2019 WIKA Alexander Wiegand SE & Co. KG, all rights reserved.
 The specifications given in this document represent the state of engineering at the time of publishing.
 We reserve the right to make modifications to the specifications and materials.

07/2019 EN

WIKA data sheet PE 81.90 · 07/2019

Page 9 of 9



WIKAL Alexander Wiegand SE & Co. KG
 Alexander-Wiegand-Straße 30
 63911 Klingenberg/Germany
 Tel. +49 9372 132-0
 Fax +49 9372 132-406
 info@wika.de
 www.wika.com

Mechanical mounting For WIKA pressure sensors and WIKA pressure switches

WIKA data sheet IN 00.14

Applications

- For fastening and sealing of a WIKA pressure sensor
- For fastening and sealing of a WIKA pressure switch

Versions

- Standard process connections
- Flush process connections
- UHP process connections
- Hygienic process connections

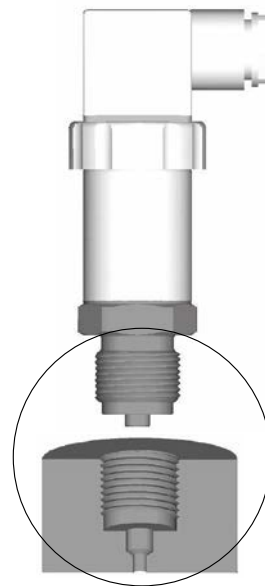

Description

WIKA offers measuring instruments with a variety of process connections in order to meet diverse customer-specific application requirements.

The customer must provide an appropriate tapped hole when installing the pressure sensor or pressure switch. This receives the WIKA pressure measuring sensor or the WIKA pressure switch.

When selecting the appropriate tapped hole, the process connection is just as critical as the thread type of the process connection and the use of the sealing. Process connections are basically divided into standard and flush process connections.

Thread types

WIKA offers process connections with various thread types which are used in numerous applications worldwide.

Types of sealing

Depending on the process connection and the medium, different sealings and sealing materials can be used. Depending on the pressure connection, the location of the sealing varies (→ For notes on sealings, see WIKA data sheet AC 09.08).

You can find further information below. Some tapped holes are available from WIKA as welding sockets. They can be ordered with the specified WIKA order number.

Making the mechanical connection

Requirements for the mounting point

The mounting point must meet the following conditions:

- The sealing faces at the pressure sensor and the measuring locations always have to be clean.
- Remove any protective cap and/or Mylar or protective foil not until shortly before installation.
- Permissible ambient temperatures remain within the performance limits of the measuring instrument. Consider possible restrictions on the ambient temperature range caused by mating connectors used.

Mechanical mounting:

1. Prior to commissioning, the pressure sensor must be subjected to a visual inspection.
Leaking liquid is indicative of damage.
2. Seal the sealing face (→ see “Sealing variants”).
3. At the mounting point, screw the pressure sensor in hand-tight.
4. When screwing in, do not cross the threads.
5. Only ever screw in, or unscrew, the instrument via the spanner flats. Never use the case as a working surface (→ see “Spanner flats”).
6. Tighten the pressure sensor with a torque spanner using the spanner flats.
The correct torque depends on the mounting point (e.g. material and shape).

Only use the pressure sensor if it is in perfect condition with respect to safety.

Only use original accessories. For accessories, see data sheet for the respective pressure sensor or pressure switch.

Additional notes for cooling element

For heat dissipation, the cooling element must not be insulated.

Additional notes for flush process connections

- Check the diaphragm for damage.
- During installation, ensure that the diaphragm is not damaged.

Additional notes for UHP process connections (models WUC-10 and WUC-15)

- For VCR®-compatible connections, the union nut/pressure screw or fitting must be tightened beyond the hand-tight position (depending on the sealings used) using a 1/8 or 1/4 turn.
- For weld-in connections, the flow of argon during the welding process is recommended for cooling.

Rework

1. The zero point must be adjusted, if necessary (→ see operating instructions).
2. Check all mechanical connections (threaded connections, welds) for leak tightness using a suitable test (e.g. helium leak test).
3. Switch the gas flow on and off at least 10 times to remove any particles that may have entered during installation. The flow rate of the gas should correspond to the subsequent process flow.

Additional information on the mounting of G1 hygienic and TRI-CLAMP® process connections

- Never loosen sealed filling screws on the measuring instrument.
- For installation, in accordance with the fitting and flange standards the appropriate fastenings, such as screws, nuts or clamp rings, must be used.
- For flange mounting, only use sealings with a sufficiently large inner diameter and centre them. Contact with the diaphragm leads to measuring deviations.
- When using a welding socket, position this so that the hole for leakage detection points downwards. Weld the welding socket flush with the inner wall of the vessel and grind down. The surface roughness of the ground surfaces must be $Ra \leq 0.8 \mu\text{m}$.
- When using soft or PTFE sealings, observe the instructions of the sealing manufacturer, particularly with regard to tightening torque and load cycles.

Spanner flats



Sealing variants

Parallel threads

For sealing, use flat gaskets, lens-type sealing rings or WIKA profile sealings at the sealing face ①.

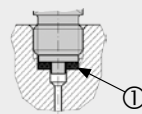

per EN 837

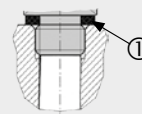

per DIN EN ISO 1179-2
(formerly DIN 3852-E)

Tapered threads

For sealing, the thread is wound with additional sealing material, e.g. PTFE tape.

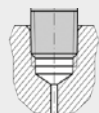

NPT, R and PT

→ For information on sealings, see WIKA data sheet AC 09.08 at www.wika.com.

Versions

Dimensions of the process connections in mm [in]



For flush process connections, see table on page 7.
The tapped holes are only shown for WIKA-specific threads. For all other tapped holes, observe the applicable standards.

Non-flush process connections

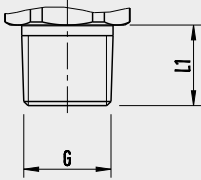
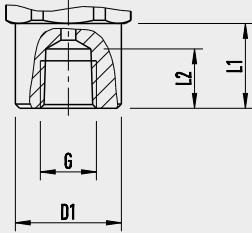
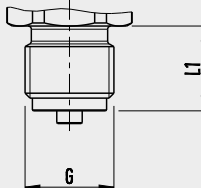
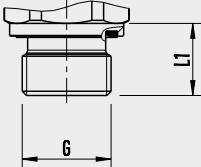
Standard	Thread	Dimensions (process connection at instrument) in mm [in]	Sketch (process connection at instrument)	
ANSI/ASME B1.20.1	1/8 NPT	G: 1/8 NPT L1: 10 [0.39]		
	1/4 NPT	G: 1/4 NPT L1: 13 [0.51]		
	1/2 NPT	G: 1/2 NPT L1: 19 [0.75]		
	1/4 NPT, female thread (for models A-10 and S-20)	G: 1/4 NPT-I D1: 25 [0.98] L1: 14 [0.55] L2: 20 [0.79]		
		1/4 NPT, female thread (for model O-10)		G: 1/4 NPT-I D1: 19 [0.75] L1: 17 [0.67] L2: 14 [0.55]
		1/4 NPT, female thread (for models C-10, E-10, F-20, N-10, P-30 and S-10)		G: 1/4 NPT-I D1: 25 [0.98] L1: 10 [0.39] L2: 14 [0.55]
DIN 16288	M12 x 1.5	G: M12 x 1.5 L1: 13 [0.51]		
	M20 x 1.5	G: M20 x 1.5 L1: 20 [0.79]		
DIN EN ISO 1179-2 (formerly DIN 3852-E)	G 1/4 A	G: G 1/4 A L1: 14 [0.55]		
	G 1/2 A	G: G 1/2 A L1: 17 [0.67]		
	M14 x 1.5	G: M14 x 1.5 L1: 14 [0.55]		

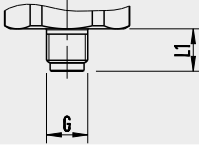
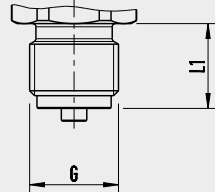
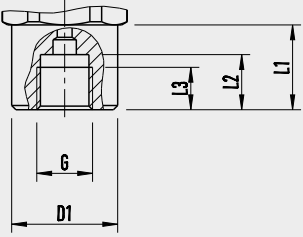
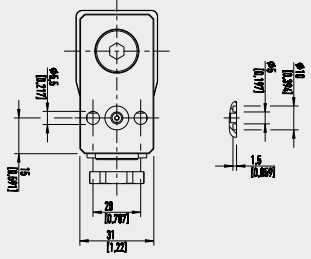
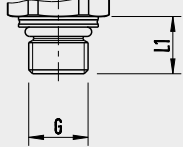
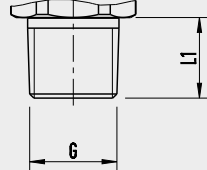
Standard	Thread	Dimensions (process connection at instrument) in mm [in]	Sketch (process connection at instrument)
EN 837	G 1/8 B	G: G 1/8 B L1: 10 [0.39]	
	G 1/4 B	G: G 1/4 B L1: 13 [0.51]	
	G 3/8 B	G: G 3/8 B L1: 16 [0.63]	
	G 1/2 B	G: G 1/2 B L1: 20 [0.79]	
	G 1/4, female thread (for models A-10, PSD-30, PSD-4 and S-20)	G: G 1/4-I D1: Ø 25 [0.98] L1: 20 [0.79] L2: 13 [0.51] L3: 10 [0.39]	
		G: G 1/4-I D1: Ø 17.5 [0.69] L1: 19.5 [0.77] L2: 13 [0.51] L3: 10 [0.39]	
		G: G 1/4-I D1: Ø 19 [0.75] L1: 17 [0.67] L2: 13 [0.51] L3: 10 [0.39]	
-	Flange connection	Diameter 5 mm	
ISO 6149-2	M14 x 1.5	G: M14 x 1.5 L1: 13.5 [0.53]	
ISO 7	R 1/4	G: R 1/4 L1: 13 [0.52]	
	R 3/8	G: R 3/8 L1: 15 [0.59]	
	R 1/2	G: R 1/2 L1: 19 [0.75]	

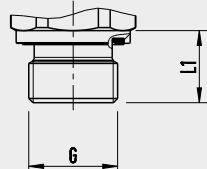
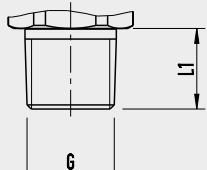
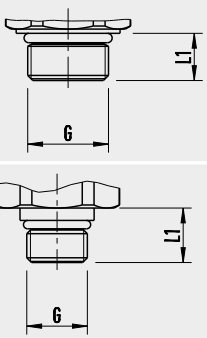
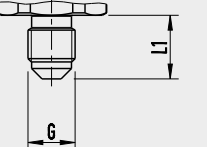
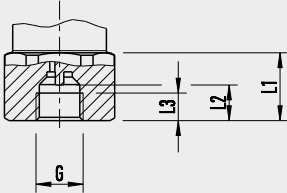
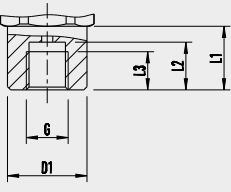
Standard	Thread	Dimensions (process connection at instrument) in mm [in]	Sketch (process connection at instrument)
JIS B2351-1	G ¼ x 10, form O with collar	G: G ¼ x 10 L1: 10 [0.39]	
	G ¾, form O with collar	G: G ¾ L1: 12 [0.47]	
KS B 0222	PT ¼	G: PT ¼ L1: 13 [0.52]	
	PT ¾	G: PT ¾ L1: 15 [0.59]	
	PT ½	G: PT ½ L1: 19 [0.75]	
SAE J514	¾-16 UNF-2A O-ring BOSS	G: ¾-16 UNF-2A L1: 11.13 [0.44]	
	7/16-20 UNF-2A O-ring BOSS	G: 7/16-20 UNF-2A L1: 12.06 [0.48]	
	9/16-18 UNF-2A O-ring BOSS	G: 9/16-20 UNF-2A L1: 12.85 [0.51]	
	7/16-20 UNF-2A 74°	G: 7/16-20 UNF-2A cone 74° L1: 15 [0.59]	
SAE J513 compatible	7/16-20 UNF-2A 90°	G: 7/16-20 UNF-2A cone 90° L1: 15 [0.59]	
SAE J515 compatible	7/16-20 UNF-2B, Schrader connection	G: 7/16-20 UNF-2B L1: 16 [0.63] L2: 8.4 [0.33] L3: 6.5 [0.26]	
Ermeto compatible	G ¼, female thread (for model PSD-4)	G: G ¼-I L1: 20 [0.79] L2: 15 [0.59] L3: 12 [0.47] D1: 25 [0.98]	
	G ¼, female thread (for model TIS-20)	G: G ¼-I L1: 20 [0.79] L2: 17.5 [0.689] L3: 14 [0.55] D1: 26.5 [1.04]	

14280340

Flush process connections

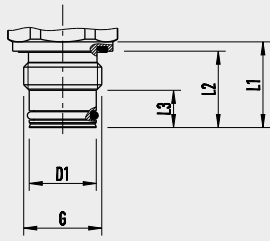
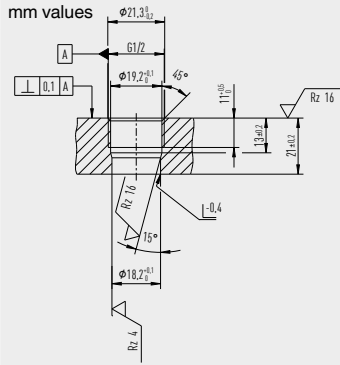
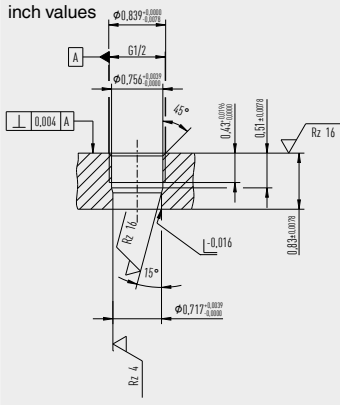
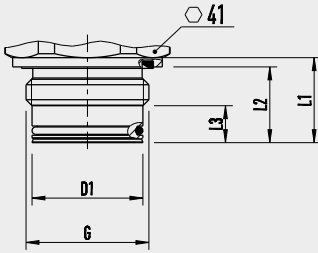
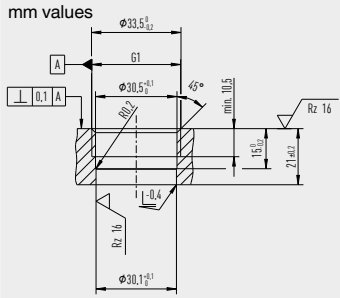
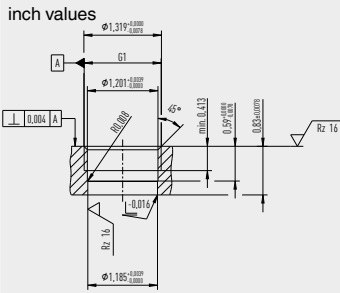
Standard	Thread	Dimensions (process connection at instrument) in mm [in]	Sketch (process connection at instrument)	Sketch (tapped hole with dimensions)
EN 837	G 1/2 B	G: G 1/2 B D1: 18 [0.71] L1: 23 [0.91] L2: 20.5 [0.807] L3: 10 [0.39]		<p>mm values</p>  <p>inch values</p> 
	G 1 B	G: G 1 B D1: 30 [1.18] L1: 23 [0.91] L2: 20.5 [0.807] L3: 10 [0.39]		<p>mm values</p>  <p>inch values</p> 

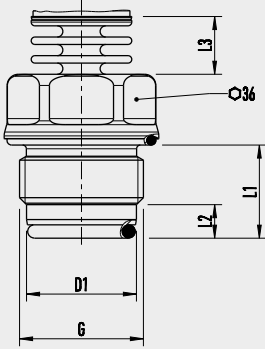
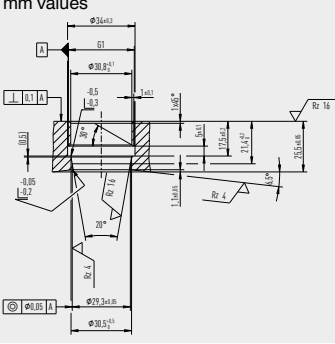
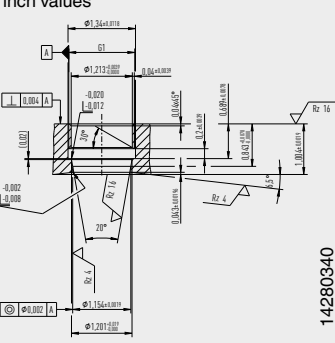
Stand-ard	Thread	Dimensions (process connection at instrument) in mm [in]	Sketch (process connection at instrument)	Sketch (tapped hole with dimensions)
EN 837	G 1 B hygienic	G: G 1 B (hygienic) D1: 29.5 [1.61] L1: 25 [0.98] L2: 9 [0.35] L3: 15.5 [0.61]		<p>mm values</p>  <p>inch values</p>  <p style="text-align: right;">14280340</p>

UHP process connections

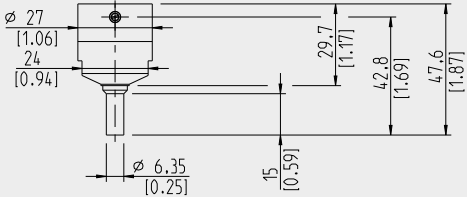
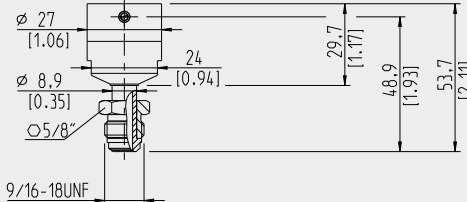
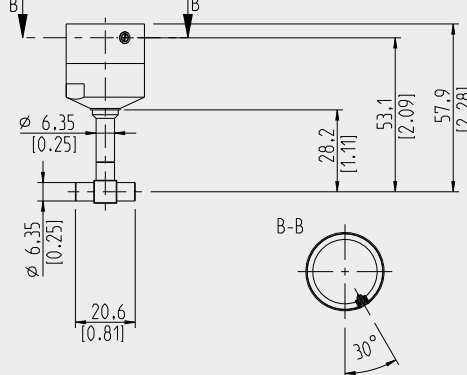
Thread	Sketch (process connection at instrument)
1/4" weld stub (Max. available pressure: 300 psi)	
1/4" pressure screw, rotatable VCR compatible	
1/4" T-connector, weld stub	

Notes

- The sketches of the process connections shown are not to scale.
- For customer-specific versions of the pressure sensors or pressure switches, other process connections can also be used, depending on agreement. The dimensions are then part of the respective agreement and correspond to the requirements of the customer's specification.

Process connections G 1 hygienic and TRI-CLAMP®

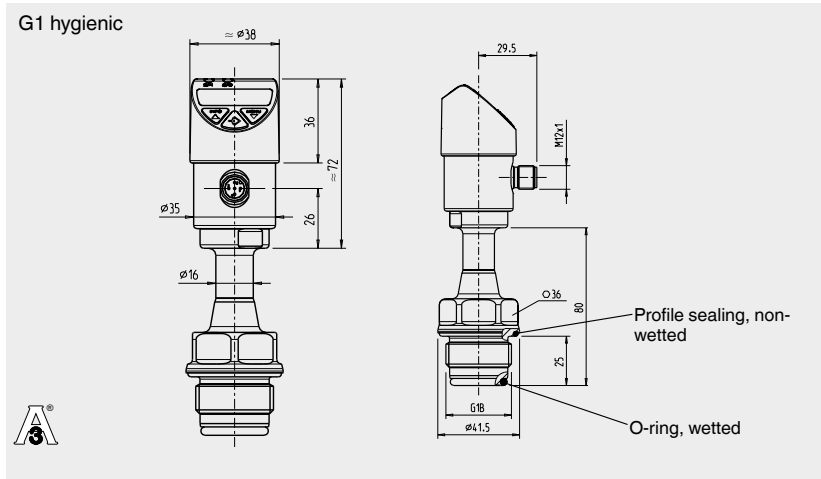

Suitable for WIKA adapter system model 910.61

For dimensions of the appropriate process adapters and welding sockets see data sheet AC 09.20

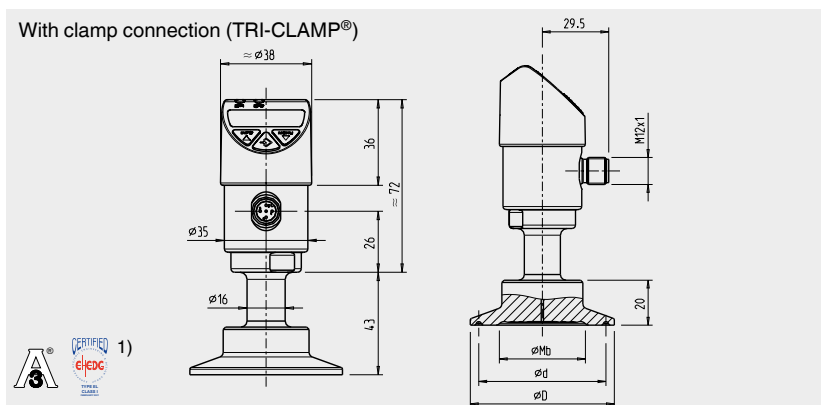

Version	Dimensions in mm		
	Ø Mb	Ø d	Ø D
Clamp connection (TRI-CLAMP®) 2) 1 ½" suitable for clamp connections per ASME BPE 1 ½", DIN 32676 row A DN 40, row C DN 1 ½", BS 4825 part 3 DN 38.1 2" suitable for clamp connections per ASME BPE 2", DIN 32676 row A DN 50, row B DN 42.4 and 48.3, row C DN 2", BS 4825 part 3 DN 50.8	32	43.5	50.5
	40	56.6	64

1) EHEDG conformity only in combination with the clamp connection with a T-ring seal from Combifit Metaalbewerking B.V.

2) For maximum pressure range consider pressure rating of clamp.

© 04/2003 WIKA Alexander Wiegand SE & Co. KG, all rights reserved.
The specifications given in this document represent the state of engineering at the time of publishing.
We reserve the right to make modifications to the specifications and materials.

07/2022 EN



WIKA Alexander Wiegand SE & Co. KG
Alexander-Wiegand-Straße 30
63911 Klingenberg/Germany
Tel. +49 9372 132-0
Fax +49 9372 132-406
info@wika.de
www.wika.de

Accessories

	Art. No.	Type No.
Straight connector, 4-pole, with PUR cable 10 m	148334	EDS-KG10
Angled connection plug, 4-pole, with PUR cable 10 m	148338	EDS-KW10