

Dirt strainer

red brass



Art. No. 147576

Type No. SCHFR.G14.MW0,25

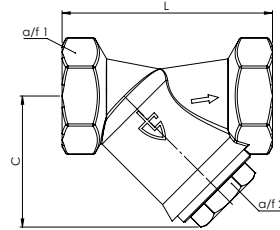
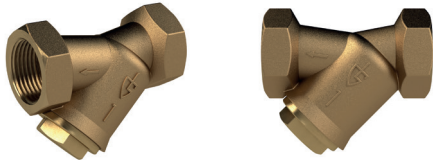

Exemplary illustration

For protecting downstream systems and fittings from contamination.

Suitable for water, neutral/non-neutral liquids, oil, compressed air and neutral/non-neutral gases, taking into account the resistance of the seal.

Technical data

Housing	red brass
Head piece	brass
Sealant	NBR
Max. operating pressure	25 bar
Operating temperature	-25 to 130 °C
Thread	G 1/4
DN	8
Mesh size	0.25 mm
Screen	double stainless steel screen

Commercial data

Customs tariff number	84813099
Country of origin	DE
eCl@ss 5.1.4	37011401
eCl@ss 9.0	37011401
UNSPSC_Code_v190501	40161532
UNSPSC_CodeDesc_v190501	Filter strainer

Dimensions

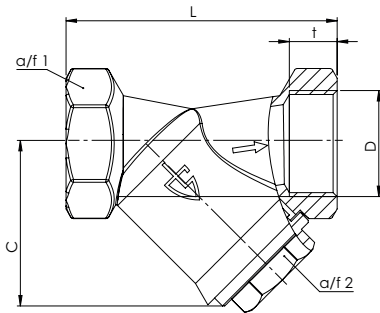

a/f 1	a/f 2	L	C	D	t
mm	mm	mm	mm	mm	mm
27	14	60.0	31.0	8.0	11.0

Spareparts

	Art. No.	Type No.
for port size G 1/4, G 3/8 and G 1/2	147761	ETSSCHFR.G14.38.12.MW0,25