

Multi-base plate »BASIC«

for pneumatic and electropneumatic way valves series 70/Basic

Art. No. 146715

Type No. 0223200201



Exemplary illustration

Light alloy multiple bases for 2 to 10 valve positions. Also suitable for valves series 70.

Technical data

| | |
|-------------|--|
| Description | Multi-base plate for 2 valve positions |
| Version | with 6 screws and gaskets |
| Connection | G 1/8 |
| Housing | Aluminium |

Commercial data

| | |
|-------------------------|----------------------------|
| Customs tariff number | 84818099 |
| Country of origin | IT |
| eCl@ss 5.1.4 | 27299205 |
| eCl@ss 9.0 | 27299205 |
| UNSPSC_Code_v190501 | 40141616 |
| UNSPSC_CodeDesc_v190501 | Valve parts or accessories |

VALVES SERIES BASIC

The valves in the BASIC series are a numerically-reduced selection of some types of the most commonly used solenoid valves. They come in sizes 1/8" and 1/4" and in the 3/2 monostable, 5/2 monostable and 5/2 bistable versions. Some production processes have been simplified, without affecting product quality and performance. The body is made of anodized aluminium (without painting) and controls are in dark grey technopolymer. BASIC valves can be assembled with accessories of other families of valves, in particular with 22 mm coils, a 8 mm hole and related connectors, modular bases and the multi-position connectors of the series 70 valves.

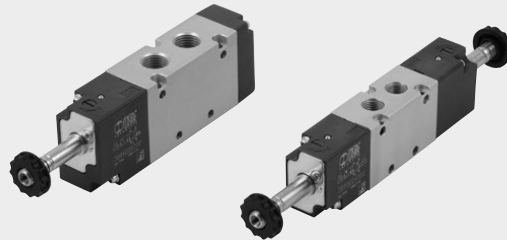

| TECHNICAL DATA | 1/8" | 1/4" |
|-------------------------------|--------------|---|
| Operating pressure: | | |
| • monostable | bar | 2.5 to 10 |
| • bistable | bar | 1 to 10 |
| Operating temperature range | °C | -10 to +60 |
| Nominal diameter | mm | 5 |
| Conductance C | Nl/min · bar | 121.43 |
| Critical ratio b | bar/bar | 0.32 |
| Flow rate at 6 bar ΔP 0.5 bar | Nl/min | 400 |
| Flow rate at 6 bar ΔP 1 bar | Nl/min | 550 |
| TRA / TRR monostable at 6 bar | ms | 15/35 |
| TRA / TRR bistable at 6 bar | ms | 20/20 |
| Coil voltage values | | 12; 24 VDC - 24; 110; 220V AC 50/60Hz |
| Power | | 2 W (DC) 3.5VA (AC) |
| Voltage tolerance | % | -10 to +15 |
| Insulation class | | F 155 |
| Maximum coil nut torque | Nm | 1 |
| Hand operator | | Bistable |
| Installation | | In any position (vertical assembly is not recommended for bistable valves subjected to vibration) |
| Fluid | | Filtered air without lubrication; lubrication, if used, must be continuous |
| Recommended lubricant | | ISO and UNI FD 22 |
| Maximum coil nut torque | Nm | 1 |
| Compatibility with oils | | See chapter Z1 |

COMPONENTS

- ① VALVE BODY: anodized aluminium
- ② CONTROL/END CAP: plastic
- ③ SPOOL: chemically nickel-plated aluminium
- ④ DISTANCE PLATES: plastic
- ⑤ GASKETS: NBR
- ⑥ PISTONS: Hostaform®
- ⑦ PISTON GASKET: NBR
- ⑧ SPRINGS: special steel
- ⑨ OPERATOR: Brass pipe - Stainless steel core

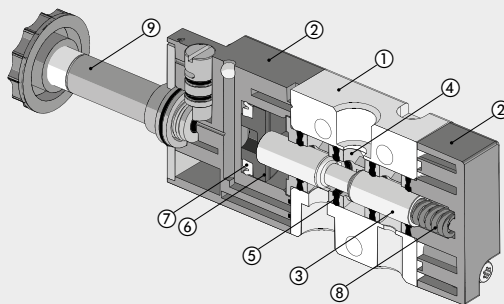

FLOW CHARTS

VALVES SERIES BASIC 1/8"

Flow rates

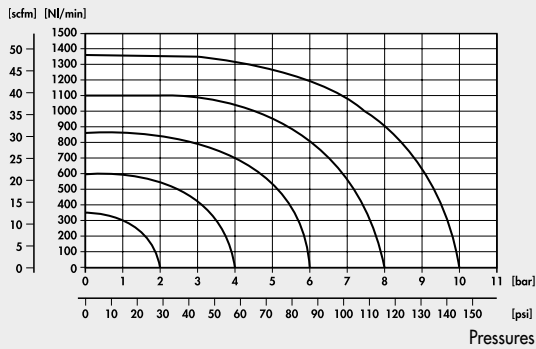

VALVES SERIES BASIC 1/4"

Flow rates

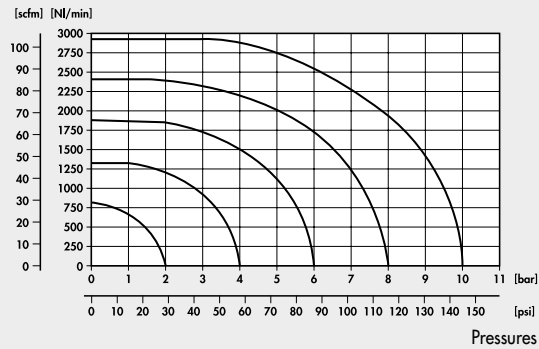

VALVES SERIES BASIC, 1/8"

MONOSTABLE 3/2 NC 1/8"

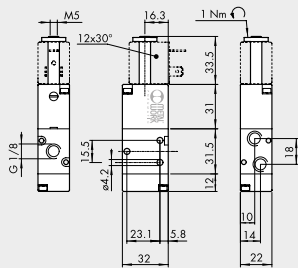

| Symbol | Code | Abbrev. | Weight [g] |
|--------|------------|---------------------|------------|
| | 7090020200 | ELPN 1/8 3/2 MON NC | 100 |

MONOSTABLE 5/2 1/8"

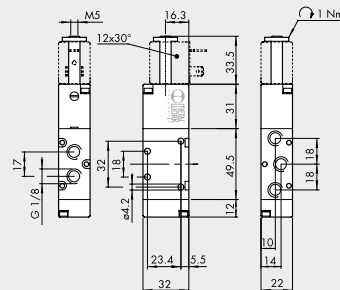

| Symbol | Code | Abbrev. | Weight [g] |
|--------|------------|------------------|------------|
| | 7090021100 | ELPN 1/8 5/2 MON | 128 |

BISTABLE 5/2 1/8"

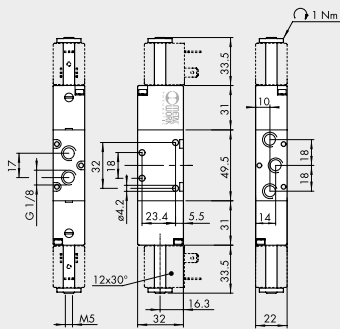

| Symbol | Code | Abbrev. | Weight [g] |
|--------|------------|------------------|------------|
| | 7090021200 | ELPN 1/8 5/2 BIS | 160 |

NOTES

VALVES

VALVES SERIES BASIC

VALVES SERIES BASIC, 1/4"

VALVES

VALVES SERIES BASIC

MONOSTABLE 3/2 NC 1/4"

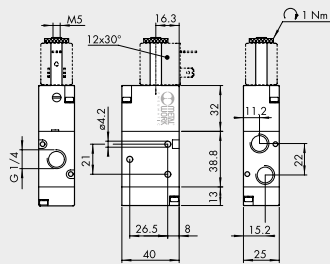

| Symbol | Code | Abbrev. | Weight [g] |
|--------|------------|---------------------|------------|
| | 7091020200 | ELPN 1/4 3/2 MON NC | 152 |

MONOSTABLE 5/2 1/4"

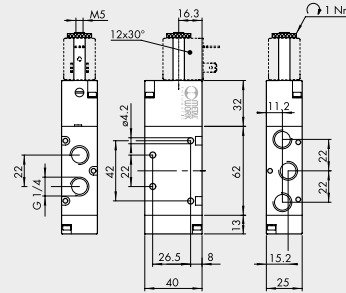

| Symbol | Code | Abbrev. | Weight [g] |
|--------|------------|------------------|------------|
| | 7091021100 | ELPN 1/4 5/2 MON | 200 |

BISTABLE 5/2 1/4"

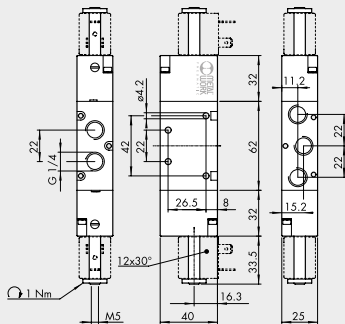

| Symbol | Code | Abbrev. | Weight [g] |
|--------|------------|------------------|------------|
| | 7091021200 | ELPN 1/4 5/2 BIS | 236 |

NOTES

ACCESSORIES

MULTIPLE BASE 1/8"

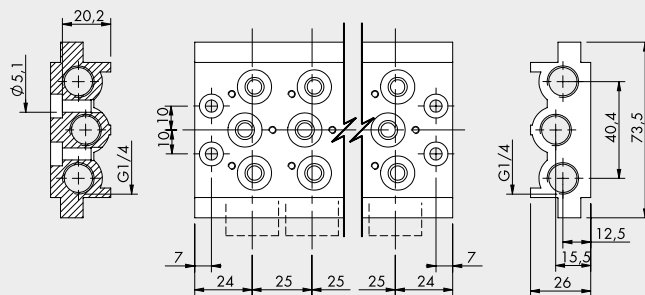

| Code | Description | Weight [g] |
|------------|--------------------------------------|------------|
| 0223200201 | 2 positions multiple base BASIC 1/8 | 236 |
| 0223200301 | 3 positions multiple base BASIC 1/8 | 321 |
| 0223200401 | 4 positions multiple base BASIC 1/8 | 407 |
| 0223200501 | 5 positions multiple base BASIC 1/8 | 494 |
| 0223200601 | 6 positions multiple base BASIC 1/8 | 587 |
| 0223200701 | 7 positions multiple base BASIC 1/8 | 711 |
| 0223200801 | 8 positions multiple base BASIC 1/8 | 760 |
| 0223200901 | 9 positions multiple base BASIC 1/8 | 842 |
| 0223201001 | 10 positions multiple base BASIC 1/8 | 923 |

Note: supplied complete with screws and gaskets

MULTIPLE BASE 1/4"

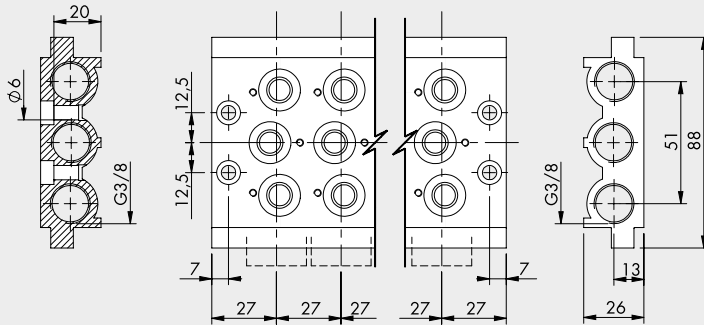

| Code | Description | Weight [g] |
|------------|--------------------------------------|------------|
| 0224200201 | 2 positions multiple base BASIC 1/4 | 296 |
| 0224200301 | 3 positions multiple base BASIC 1/4 | 406 |
| 0224200401 | 4 positions multiple base BASIC 1/4 | 515 |
| 0224200501 | 5 positions multiple base BASIC 1/4 | 624 |
| 0224200601 | 6 positions multiple base BASIC 1/4 | 733 |
| 0224200701 | 7 positions multiple base BASIC 1/4 | 845 |
| 0224200801 | 8 positions multiple base BASIC 1/4 | 956 |
| 0224200901 | 9 positions multiple base BASIC 1/4 | 1055 |
| 0224201001 | 10 positions multiple base BASIC 1/4 | 1086 |

Note: supplied complete with screws and gaskets

GASKET KIT

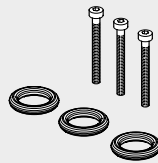

| Code | Description | Weight [g] |
|------------|-------------------------|------------|
| 0226004701 | Gasket kit for 1/8 base | 5 |
| 0226005701 | Gasket kit for 1/4 base | 5 |

MANIFOLD BASES



Refer to page B1.44 for manifold bases

MANIFOLDS



Refer to page B1.43 for manifolds

COILS AND CONNECTORS

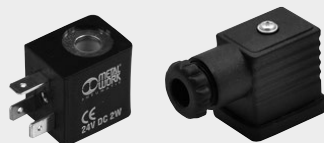

Refer to page B1.60 for coils and connectors

VALVES

VALVES SERIES BASIC

Accessories

| | Art. No. | Type No. |
|---|-----------------|-----------------|
| Blanking plate G 1/4 manifold base for G 1/8 conn. surface | 106631 | 520.18-A |
| Plugs for multiple manifold base, G 1/8 | 119139 | 520.18-V |
| Omega adapter f. manifold base system/multi-base pl., G 1/8 | 146737 | 0226004600 |
| Intermediate plugs for multiple manifold base, G 1/8 | 129152 | 520.18-Z |

Spareparts

| | Art. No. | Type No. |
|--|-----------------|-----------------|
| Set of gasket (parts subject to wear), G 1/8 | 129904 | 520.18-DS |