

5/2-way valve »BASIC«

electropneumatic

EASY

Art. No. 146714

Type No. 7091021200

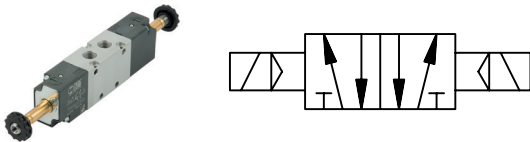

Exemplary illustration

The valves in the »BASIC« series are a numerically-reduced selection of some types of the most commonly used solenoid valves with a particularly good price/performance ratio. Some production processes have been simplified, without affecting product quality and performance. The body is made of anodized aluminium (without painting) and controls are in dark grey technopolymer.

»BASIC« valves can be assembled with accessories of other families of valves, in particular with 22 mm coils, a 8 mm hole and related connectors, modular bases and the multi-position connectors of the series 70 valves.

Technical data

Operating pressure	1 - 10 bar
Medium temperature	-10 to 60 °C
Ambient temperature	-10 to 60 °C
Medium	Filtered compressed air with or without lubrication. If lubricated, then continuous.
Sealant	NBR
Flow rate measurement 1	Flow rate at 6 bar and Δp 0.5 bar
Flow rate 1	750 NI/min
Flow rate measurement 2	Flow rate at 6 bar and Δp 1.0 bar
Flow rate 2	1100 NI/min
Connection	G 1/4
DN	7.5
Function	5/2
Operation	bistable
Manual control	latching
Symbol	36
Series	Basic
TechnischerHinweis1	Plug and coil are not included in delivery!

Commercial data

Customs tariff number	84818079
Country of origin	IT
eCl@ss 5.1.4	27291501
eCl@ss 9.0	27291390
UNSPSC_Code_v190501	40141603
UNSPSC_CodeDesc_v190501	Pneumatic valves

VALVES SERIES BASIC

The valves in the BASIC series are a numerically-reduced selection of some types of the most commonly used solenoid valves. They come in sizes 1/8" and 1/4" and in the 3/2 monostable, 5/2 monostable and 5/2 bistable versions. Some production processes have been simplified, without affecting product quality and performance. The body is made of anodized aluminium (without painting) and controls are in dark grey technopolymer. BASIC valves can be assembled with accessories of other families of valves, in particular with 22 mm coils, a 8 mm hole and related connectors, modular bases and the multi-position connectors of the series 70 valves.

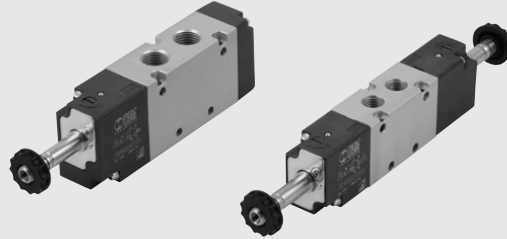

TECHNICAL DATA	1/8"	1/4"
Operating pressure:		
• monostable	bar	2.5 to 10
• bistable	bar	1 to 10
Operating temperature range	°C	-10 to +60
Nominal diameter	mm	5
Conductance C	Nl/min · bar	121.43
Critical ratio b	bar/bar	0.32
Flow rate at 6 bar ΔP 0.5 bar	Nl/min	400
Flow rate at 6 bar ΔP 1 bar	Nl/min	550
TRA / TRR monostable at 6 bar	ms	15/35
TRA / TRR bistable at 6 bar	ms	20/20
Coil voltage values		12; 24 VDC - 24; 110; 220V AC 50/60Hz
Power		2 W (DC) 3.5VA (AC)
Voltage tolerance	%	-10 to +15
Insulation class		F 155
Maximum coil nut torque	Nm	1
Hand operator		Bistable
Installation		In any position (vertical assembly is not recommended for bistable valves subjected to vibration)
Fluid		Filtered air without lubrication; lubrication, if used, must be continuous
Recommended lubricant		ISO and UNI FD 22
Maximum coil nut torque	Nm	1
Compatibility with oils		See chapter Z1

COMPONENTS

- ① VALVE BODY: anodized aluminium
- ② CONTROL/END CAP: plastic
- ③ SPOOL: chemically nickel-plated aluminium
- ④ DISTANCE PLATES: plastic
- ⑤ GASKETS: NBR
- ⑥ PISTONS: Hostaform®
- ⑦ PISTON GASKET: NBR
- ⑧ SPRINGS: special steel
- ⑨ OPERATOR: Brass pipe - Stainless steel core

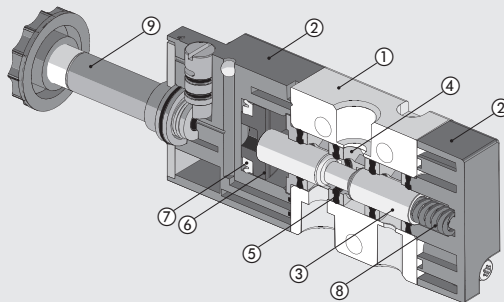

VALVES SERIES BASIC, 1/4"

VALVES

VALVES SERIES BASIC

MONOSTABLE 3/2 NC 1/4"

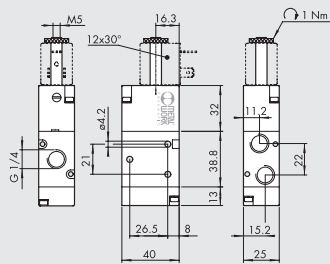

Symbol	Code	Abbrev.	Weight [g]
	7091020200	ELPN 1/4 3/2 MON NC	152

MONOSTABLE 5/2 1/4"

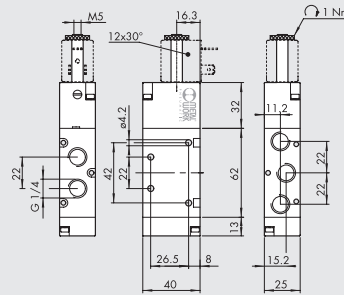

Symbol	Code	Abbrev.	Weight [g]
	7091021100	ELPN 1/4 5/2 MON	200

BISTABLE 5/2 1/4"

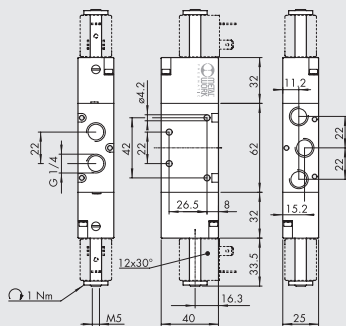

Symbol	Code	Abbrev.	Weight [g]
	7091021200	ELPN 1/4 5/2 BIS	236

NOTES

ACCESSORIES

MULTIPLE BASE 1/8"

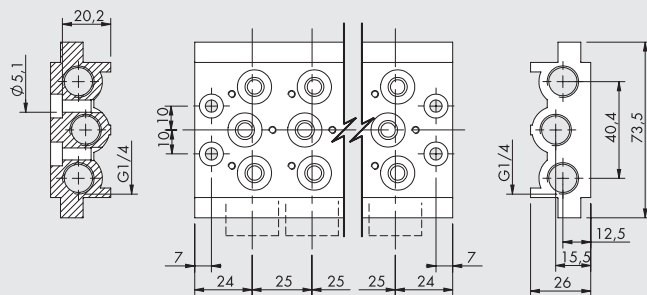

Code	Description	Weight [g]
0223200201	2 positions multiple base BASIC 1/8	236
0223200301	3 positions multiple base BASIC 1/8	321
0223200401	4 positions multiple base BASIC 1/8	407
0223200501	5 positions multiple base BASIC 1/8	494
0223200601	6 positions multiple base BASIC 1/8	587
0223200701	7 positions multiple base BASIC 1/8	711
0223200801	8 positions multiple base BASIC 1/8	760
0223200901	9 positions multiple base BASIC 1/8	842
0223201001	10 positions multiple base BASIC 1/8	923

Note: supplied complete with screws and gaskets

MULTIPLE BASE 1/4"

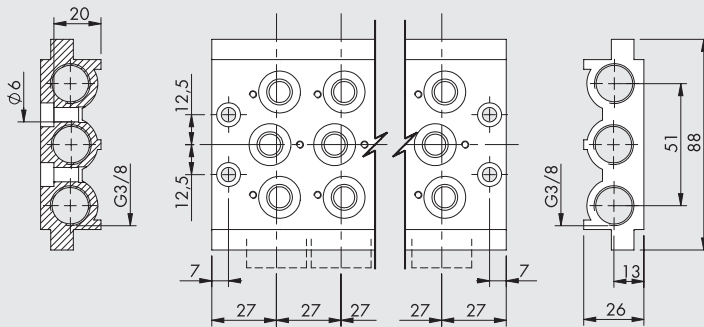

Code	Description	Weight [g]
0224200201	2 positions multiple base BASIC 1/4	296
0224200301	3 positions multiple base BASIC 1/4	406
0224200401	4 positions multiple base BASIC 1/4	515
0224200501	5 positions multiple base BASIC 1/4	624
0224200601	6 positions multiple base BASIC 1/4	733
0224200701	7 positions multiple base BASIC 1/4	845
0224200801	8 positions multiple base BASIC 1/4	956
0224200901	9 positions multiple base BASIC 1/4	1055
0224201001	10 positions multiple base BASIC 1/4	1086

Note: supplied complete with screws and gaskets

GASKET KIT

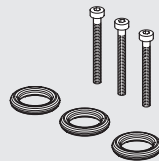

Code	Description	Weight [g]
0226004701	Gasket kit for 1/8 base	5
0226005701	Gasket kit for 1/4 base	5

MANIFOLD BASES



Refer to page B1.44 for manifold bases

MANIFOLDS



Refer to page B1.43 for manifolds

COILS AND CONNECTORS



Refer to page B1.60 for coils and connectors

VALVES

VALVES SERIES BASIC

Accessories

	Art. No.	Type No.
Solenoid 12 V DC, 2 W	118631	400-514-41
Solenoid 24 V DC, 2 W	118632	400-514-42
Solenoid 24 V AC, 50/60 Hz, 3,5 VA	118628	400-514-01
Solenoid 110 V AC, 50/60 Hz, 3,5 VA	118629	400-514-07
Solenoid 230 V AC, 50/60 Hz, 3,5 VA	118630	400-514-17
Plug connector, standard, industrial form B, black	117313	1920.9P
Plug connector with LED, 24 V, transparent	117316	1920.9PL.42
Plug connector with LED, 110 V, transparent	151011	1920.9PL110
Plug connector with LED, 230 V, transparent	117314	1920.9PL.17
Plug connector with LED, varistor 24 V, transparent	117318	1920.9PLV42
Plug connector with LED, varistor 110 V, transparent	129849	1920.9PLV110
Plug connector with LED, varistor 230 V, transparent	117317	1920.9PLV17
Feed block with 2 valve positions	106616	519.02-14
Feed block with 3 valve positions	106617	519.03-14
Feed block with 4 valve positions	106618	519.04-14
Feed block with 5 valve positions	106619	519.05-14
Feed block with 6 valve positions	106620	519.06-14
Feed block with 7 valve positions	106621	519.07-14
Mounting bracket set, height 120.0 mm	106607	518.120-14
Mounting bracket set, height 60.0 mm	106608	518.60-14
Mounting bracket set, height 30.0 mm	106609	518.30-14