

Coaxial valve

pneumatically operated

EASY

Art. No. 146445

Type No. 351.915-1

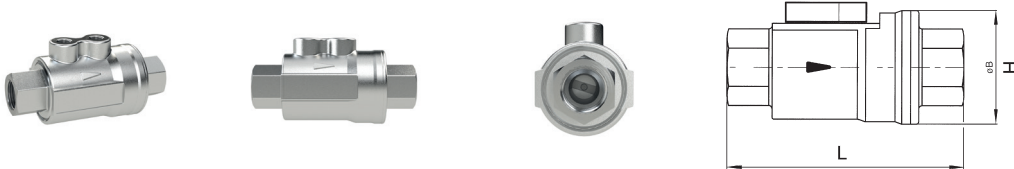

Exemplary illustration

2/2-way coaxial valves, specially designed for automated industrial plant engineering.

A low-price, compact, space-saving and reliable alternative to ball valves with a pneumatic rotary actuator.

These valves have a full bore and - owing to the optimised design - only minimal flow losses.

They are controlled by means of filtered compressed air.

Technical data

Housing	Nickel-plated brass
Max. operating pressure	10 bar
Min. pilot pressure	3 bar
Max. pilot pressure	8 bar
Min. operating temperature	-20 °C
Max. operating temperature	80 °C
Control medium	filtered, dry compressed air
Flow medium	non-aggressive gases and liquids
Flow rate kv value	25 m ³ /h
Flow direction	any
Connection	2 x G 1/8 (NAMUR interface only with adapter)
Thread	Rp 1 1/4
Internal parts	Nickel-plated brass
Spring	Stainless steel
Mounting position	any
Version	double-acting
Type of construction	Piston valve (special piston design for 100 % passage)
Operation	air-actuated at both ends
Sealant	NBR
DN	32
H	86 mm
L	165 mm
Weight	2,8 kg

Commercial data

Customs tariff number	84818069
Country of origin	IT
eCl@ss 5.1.4	27292002
eCl@ss 9.0	27292002
UNSPSC_Code_v190501	40141603
UNSPSC_CodeDesc_v190501	Pneumatic valves

Flow chart

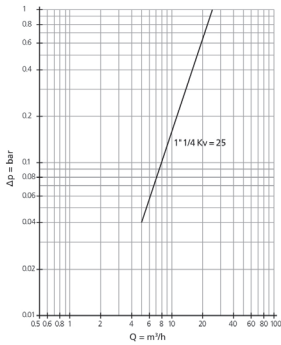

Dimensions

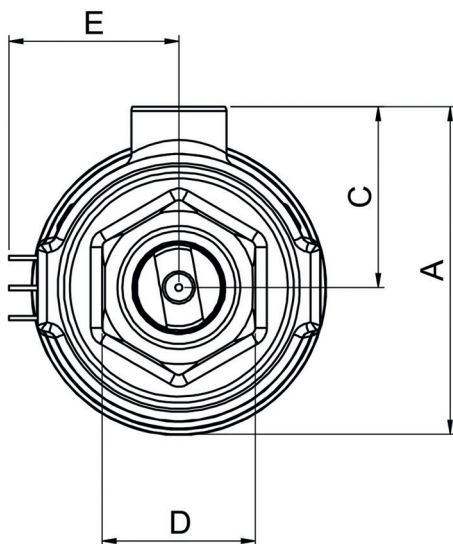

A	C	D	E
mm	mm	mm	mm
91	48	50	45,7

Further information

- No moving external parts (reduced risk of accidents)
- Directly mountable control valve
- Choice of two sealing materials for a wide range of applications

Accessories

	Art. No.	Type No.
NAMUR adapter plate for angle-seat valves G 1/2 - G 2	131434	NAP