

## Adapter for pressure gauges

Art. No. 145477

Type No. 9210005



Exemplary illustration

### Technical data

|             |   |
|-------------|---|
| Description | Adapter for pressure gauges, G 1/4 ET, G 1/8 IT |
|-------------|---|

### Commercial data

|                         |                            |
|-------------------------|----------------------------|
| Customs tariff number   | 74122000                   |
| Country of origin       | IT                         |
| eCl@ss 5.1.4            | 27200691                   |
| eCl@ss 9.0              | 27200691                   |
| UNSPSC_Code_v190501     | 40141616                   |
| UNSPSC_CodeDesc_v190501 | Valve parts or accessories |

**SYNTESI® ACCESSORIES**



**MOUNTING BRACKET FOR REG. AND FR KNOB**



| Code    | Description              |
|---------|--------------------------|
| 9200701 | SF100 - BIT-ND 1/4 - SY1 |
| 9400701 | SF200 - ND-3/8 1/2 - SY2 |

| Code    | A  | B  | C  | D   | E    |
|---------|----|----|----|-----|------|
| 9200701 | 32 | 20 | 12 | 5.5 | 14.2 |
| 9400701 | 42 | 40 | 12 | 5.5 | 15   |

**MOUNTING BRACKET**

Vertical mounting

Horizontal mounting

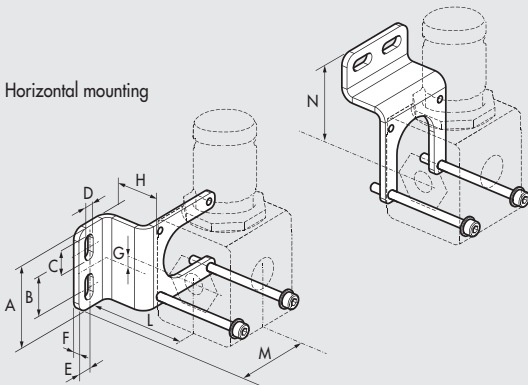

| Code     | Description          |
|----------|----------------------|
| 9200716X | Mounting bracket SY1 |
| 9200717X | Mounting bracket SY2 |

Note: Supplie complete with screws and washers.  
Max torque 0.8 Nm for SY1 - Max torque 2.0 Nm for SY2  
Codes to be used for units in the standard and the anti-corrosion version

| Code     | A    | B  | C    | D   | E | F | G   | H  | L    | M    | N    |
|----------|------|----|------|-----|---|---|-----|----|------|------|------|
| 9200716X | 41.5 | 20 | 12.7 | 5.5 | 7 | 3 | 0.8 | 25 | 43.8 | 46.5 | 47   |
| 9200717X | 60   | 40 | 12.7 | 5.5 | 8 | 3 | 1.3 | 30 | 57.5 | 58.3 | 59.5 |

**CONNECTION BRACKETS ON THE BAR (DIN EN50022)**



| Code     | Description                               |
|----------|---|
| 9200718X | Connection brackets on DIN bar, SY1 - SY2 |

Note: 2 pieces per pack complete with screws and washers.  
Max torque 0.8 Nm for SY1 - Max torque 2.0 Nm for SY2  
Codes to be used for units in the standard and the anti-corrosion version

**PRESSURE GAUGES**



| Code    | Description  |
|---------|--------------|
| 9700101 | M 40 1/8 012 |
| 9700102 | M 40 1/8 04  |
| 9800101 | M 50 1/8 012 |
| 9800102 | M 50 1/8 04  |
| 9900101 | M 63 1/4 012 |



|         |                 |
|---------|-----------------|
| 9700109 | M 40x40 1/8 04  |
| 9700110 | M 40x40 1/8 012 |

**ADAPTERS FOR PRESSURE GAUGES (SY2)**

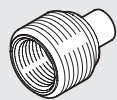

| Code    | Description                        |
|---------|------------------------------------|
| 9210005 | 1/4 adapter for 1/8 pressure gauge |

**COIL 22 mm FOR APR AND V3V ELPN**



| Code        | Description                 |
|-------------|-----------------------------|
| W0215000151 | Coil 22 Ø 8 BA 2W-12VDC     |
| W0215000101 | Coil 22 Ø 8 BA 2W-24VDC     |
| W0215000111 | Coil 22 Ø 8 BA 3.5VA-24VAC  |
| W0215000121 | Coil 22 Ø 8 BA 3.5VA-110VAC |
| W0215000131 | Coil 22 Ø 8 BA 3.5VA-220VAC |

Electrical connection DIN 43650 B-IND

**"UL" AND "CSA" COILS 22 mm**

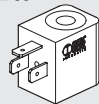

| Code        | Description                    |
|-------------|--------------------------------|
| W0215000251 | Coil 22 Ø 8 BA 2W-12VDC UR     |
| W0215000201 | Coil 22 Ø 8 BA 2W-24VDC UR     |
| W0215000211 | Coil 22 Ø 8 BA 3.5VA-24VAC UR  |
| W0215000221 | Coil 22 Ø 8 BA 3.5VA-110VAC UR |
| W0215000231 | Coil 22 Ø 8 BA 3.5VA-220VAC UR |

Electrical connection DIN 43650 B-IND

**COIL 30 mm FOR APR AND V3V ELPN**

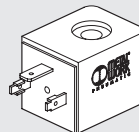

| Code        | Description                       |
|-------------|-----------------------------------|
| W0210010100 | Coil 30 Ø 8 2W-24VDC              |
| W0210011100 | Coil 30 Ø 8 3.5VA-24VAC 50/60 HZ  |
| W0210012100 | Coil 30 Ø 8 3.5VA-110VAC 50/60 HZ |
| W0210013100 | Coil 30 Ø 8 3.5VA-220VAC 50/60 HZ |

Electrical connection DIN 43650 - A

UNITS

SYNTESI® ACCESSORIES

**KIT FOR COIL EEXM**



| Code       | Description                             |
|------------|---|
| 0227606913 | Kit for coil 30 24 VDC EEXMT5 cable 3m  |
| 0227606915 | Kit for coil 30 24 VDC EEXMT5 cable 5m  |
| 0227608013 | Kit for coil 30 24 VAC EEXMT5 cable 3m  |
| 0227608015 | Kit for coil 30 24 VAC EEXMT5 cable 5m  |
| 0227608023 | Kit for coil 30 110 VAC EEXMT5 cable 3m |
| 0227608025 | Kit for coil 30 110 VAC EEXMT5 cable 5m |
| 0227608033 | Kit for coil 30 230 VAC EEXMT5 cable 3m |
| 0227608035 | Kit for coil 30 230 VAC EEXMT5 cable 5m |

According to ATEX 2014/34/EU rule,  
 II 2G Ex mb IIC T4/T5 Gb  
 II 2D Ex tb IIIC T130/T95 °C IP66 Db  
 N.B.: Supplied complete with adapter for Ø8 mm sleeve

**ELECTRIC CONNECTOR 22 mm FOR COILS DIN 43650 B-IND**

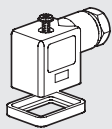

| Code        | Description               |
|-------------|---------------------------|
| W0970510011 | Connector standard        |
| W0970510012 | Connector 22 LED 24V      |
| W0970510013 | Connector 22 LED 110V     |
| W0970510014 | Connector 22 LED 220V     |
| W0970510015 | Connector 22 LED VDR 24V  |
| W0970510016 | Connector 22 LED VDR 110V |
| W0970510017 | Connector 22 LED VDR 220V |
| W0970510070 | Connector 22 II 2 GD ATEX |

**ELECTRIC CONNECTOR 30 mm FOR COILS DIN 43650-A**

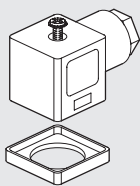

| Code        | Description               |
|-------------|---------------------------|
| W0970520033 | Connector 30 STD          |
| W0970520034 | Connector 30 LED 24V      |
| W0970520035 | Connector 30 LED 110V     |
| W0970520036 | Connector 30 LED 220V     |
| W0970520037 | Connector 30 LED VDR 24V  |
| W0970520038 | Connector 30 LED VDR 110V |
| W0970520039 | Connector 30 LED VDR 220V |

**M8 STRAIGHT CONNECTOR WITH CABLE FOR PRESSURE SWITCHES**

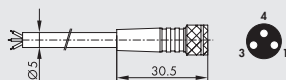

| Pin | Cable color |
|-----|-------------|
| 1   | Brown       |
| 3   | Blue        |
| 4   | Black       |

| Code       | Description  |
|------------|--|
| 02400A0100 | M8 female 3 PIN HIGH FLEX CL6 connector with cable L = 1 m   |
| 02400A0250 | M8 female 3 PIN HIGH FLEX CL6 connector with cable L = 2.5 m |
| 02400A0500 | M8 female 3 PIN HIGH FLEX CL6 connector with cable L = 5 m   |
| 02400A1000 | M8 female 3 PIN HIGH FLEX CL6 connector with cable L = 10 m  |

Mobile laying cable, class 6 according to IEC 60228

**KIT COIL SIDE 22 IP65**



| Code       | Description             |
|------------|-------------------------|
| 0222100100 | Kit for coils 22 - IP65 |

Improved IP65 protection, even after prolonged exposure to atmospheric agents.

**THREADED PORT**

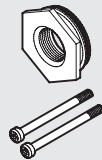

| Code     | Description                       |
|----------|-----------------------------------|
| 9210001  | Kit IN OUT 1/8 SY1                |
| 9210002  | Kit IN OUT 1/4 SY1                |
| 9210003  | Kit IN OUT 3/8 SY1                |
| 9210011  | Kit IN OUT 3/8 SY2                |
| 9210012  | Kit IN OUT 1/2 SY2                |
| 9210013  | Kit IN OUT 3/4 SY2                |
| 9210014  | Kit IN OUT 1 SY2                  |
| 9210001X | Kit IN OUT 1/8 SY1 anti-corrosion |
| 9210002X | Kit IN OUT 1/4 SY1 anti-corrosion |
| 9210003X | Kit IN OUT 3/8 SY1 anti-corrosion |
| 9210011X | Kit IN OUT 3/8 SY2 anti-corrosion |
| 9210012X | Kit IN OUT 1/2 SY2 anti-corrosion |
| 9210013X | Kit IN OUT 3/4 SY2 anti-corrosion |
| 9210014X | Kit IN OUT 1 SY2 anti-corrosion   |

Max torque 0.4 Nm for SY1  
 Max torque 2.5 Nm for SY2

**CONNECTING NIPPLE KIT**

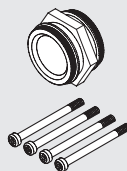

| Code     | Description                              |
|----------|--|
| 9210000  | Connecting nipple kit SY1                |
| 9210010  | Connecting nipple kit SY2                |
| 9210000X | Connecting nipple kit SY1 anti-corrosion |
| 9210010X | Connecting nipple kit SY2 anti-corrosion |

Max torque 0.4 Nm for SY1  
 Max torque 2.5 Nm for SY2

**90° CONNECTING ELEMENT KIT**

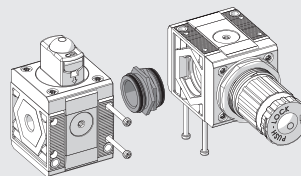

| Code     | Description                                   |
|----------|---|
| 9210009  | 90° SY1 connection element kit                |
| 9210019  | 90° SY2 connection element kit                |
| 9210009X | 90° anti-corrosion SY1 connection element kit |
| 9210019X | 90° anti-corrosion SY2 connection element kit |

Max torque 0.4 Nm for SY1  
 Max torque 2.5 Nm for SY2

**KIT CONNECTING REGTRONIC 1/4 (PAGE C6.10)  
AND GS REGULATOR (PAGE C6.2)**



| Code    | Description                   |
|---------|-------------------------------|
| 9210004 | Adapter for regtronic 1/4 SY1 |

Max torque for screw, 0.4 Nm

**Instructions:**

- 1) Screw the connecting bushing onto the REGTRONIC 1/4 as far as it will go.  
Use sealant on the G1/4 thread to provide a further seal.
- 2) Unscrew the bushing slightly until two surfaces of the hexagon are parallel to the body of REGTRONIC 1/4 (see diagram).
- 3) Insert the bushing into the Syntesis® unit.
- 4) Tighten the two self-tapping screws in the Syntesis® unit to a torque of 0.4 Nm max.

**SY1 - SY2 SIZE ADAPTER**



| Code     | Description                           |
|----------|---------------------------------------|
| 9210006  | SY1 - SY2 size adapter                |
| 9210006X | SY1 - SY2 size adapter anti-corrosion |

Max torque for screw, 0.4 Nm for SY1  
Max torque for screw, 2.5 Nm for SY2

**SY1 - SY2 KIT FOR CONNECTION TO FLUX 1 - 2**



| Code       | Description          |
|------------|----------------------|
| 900099A002 | Adapter FLUX 1 - SY1 |
| 900099A003 | Adapter FLUX 2 - SY2 |

Max torque for screw, 0.4 Nm for SY1  
Max torque for screw, 2.5 Nm for SY2  
See page C6.33 for the assembly diagram.

**SY1 - SY2 KIT FOR CONNECTION TO SERIE 70 SAFE AIR® VALVES**



| Code    | Description                 |
|---------|-----------------------------|
| 9210015 | IN 1/4 SY1 block accessory  |
| 9210016 | OUT 1/4 SY1 block accessory |
| 9210022 | IN 3/8 SY1 block accessory  |
| 9210023 | OUT 3/8 SY1 block accessory |
| 9210017 | IN 3/8 SY2 block accessory  |
| 9210018 | OUT 3/8 SY2 block accessory |
| 9210020 | IN 1/2 SY2 block accessory  |
| 9210021 | OUT 1/2 SY2 block accessory |

Max torque for screw, 0.4 Nm for SY1  
Max torque for screw, 2.5 Nm for SY2

See page B1.151 for the assembly diagram.

**BOWL DISASSEMBLY SPANNER**

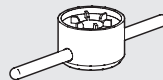

| Code    | Description        |
|---------|--------------------|
| 9170601 | CS TF - TL BIT/SY1 |
| 9210050 | CS TF - TL SY2     |

**WALL-FIXING SCREW**



| Code    | Description              |
|---------|--------------------------|
| 9210030 | M4 x 55 fixing screw SY1 |
| 9210031 | M5 x 75 fixing screw SY2 |

Max torque 0.8 Nm for SY1  
Max torque 2.0 Nm for SY2

**PADLOCK**



| Code    | Description |
|---------|-------------|
| 9062401 | Padlock     |

UNITS

Syntesis® ACCESSORIES

# SYNTESI® SPARE PARTS

UNITS

Syntesi® SPARE PARTS

### AUTOMATIC DRAIN (RA)

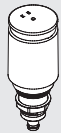

| Code    | Description                   |
|---------|-------------------------------|
| 9000802 | RA automatic drain spare part |

### AUTOMATIC DRAIN (SAC)



| Code    | Description                |
|---------|----------------------------|
| 9000803 | Spares SAC automatic drain |

### BOWL RMSA/RA/SAC

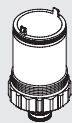

| Code    | Description              |
|---------|--------------------------|
| 9210100 | Bowl FIL FR DEP RMSA SY1 |
| 9210101 | Bowl FIL FR RA SY1       |
| 9210102 | Bowl FIL FR DEP SAC SY1  |
| 9210105 | Bowl FIL FR DEP RMSA SY2 |
| 9210106 | Bowl FIL FR RA SY2       |
| 9210107 | Bowl FIL FR DEP SAC SY2  |

### LUBRICATOR BOWL



| Code    | Description  |
|---------|--------------|
| 9210110 | Bowl LUB SY1 |
| 9210115 | Bowl LUB SY2 |

### FILTERING ELEMENT

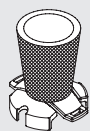

| Code    | Description                        |
|---------|------------------------------------|
| 9210150 | Filtering element 5µm (yellow) SY1 |
| 9210151 | Filtering element 20µm (white) SY1 |
| 9210152 | Filtering element 50µm (blue) SY1  |
| 9210155 | Filtering element 5µm (yellow) SY2 |
| 9210156 | Filtering element 20µm (white) SY2 |
| 9210157 | Filtering element 50µm (blue) SY2  |

### PURIFIER FILTERING ELEMENT



| Code    | Description              |
|---------|--------------------------|
| 9210160 | Cartridge 0.01µm DEP SY1 |
| 9210165 | Cartridge 0.01µm DEP SY2 |
| 9210162 | Cartridge 1µm DEP SY1    |
| 9210167 | Cartridge 1µm DEP SY2    |

### AC FILTERING ELEMENT (ACTIVE CARBON)



| Code    | Description      |
|---------|------------------|
| 9210161 | Cartridge AC SY1 |
| 9210166 | Cartridge AC SY2 |

### TRANSPARENT LUBRICATOR COVER

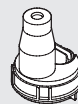

| Code    | Description               |
|---------|---------------------------|
| 9210180 | Transparent cover LUB SY1 |
| 9210185 | Transparent cover LUB SY2 |

### LUBRICATOR OIL-FILLING CAP



| Code    | Description             |
|---------|-------------------------|
| 9210181 | Oil-filling cap LUB SY1 |
| 9210186 | Oil-filling cap LUB SY2 |

### SPRINGS FOR REGULATORS AND FR



| Code     | Description                         |
|----------|-------------------------------------|
| 9210190  | Spares MO 02 SY1                    |
| 9210191  | Spares MO 04 SY1/SY1 anti-corrosion |
| 9210192  | Spares MO 08 SY1                    |
| 9210193  | Spares MO 012 SY1                   |
| 9210195  | Spares MO 02 SY2                    |
| 9210196  | Spares MO 04 SY2                    |
| 9210197  | Spares MO 08 SY2                    |
| 9210198  | Spares MO 012 SY2                   |
| 9210192X | Spares 08 SY1 anti-corrosion        |
| 9210193X | Spares 012 SY1 anti-corrosion       |
| 9210197X | Spares 08 SY2 anti-corrosion        |
| 9210198X | Spares 012 SY2 anti-corrosion       |

### BELL FOR REG AND FR

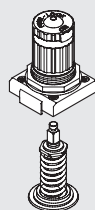

| Code     | Description                 |
|----------|-----------------------------|
| 9210200  | Bell 02 SY1                 |
| 9210201  | Bell 04 SY1                 |
| 9210202  | Bell 08 SY1                 |
| 9210203  | Bell 012 SY1                |
| 9210220  | Bell 02 SY2                 |
| 9210221  | Bell 04 SY2                 |
| 9210222  | Bell 08 SY2                 |
| 9210223  | Bell 012 SY2                |
| 9210202X | Bell 08 SY1 anti-corrosion  |
| 9210203X | Bell 012 SY1 anti-corrosion |
| 9210222X | Bell 08 SY2 anti-corrosion  |
| 9210223X | Bell 012 SY2 anti-corrosion |

**POPPET FOR REG**



| Code     | Description                   |
|----------|-------------------------------|
| 9210210  | Poppet REG SY1                |
| 9210230  | Poppet REG SY2                |
| 9210210X | Poppet REG SY1 anti-corrosion |
| 9210230X | Poppet REG SY2 anti-corrosion |

**NOTES**

**POPPET FOR FR**

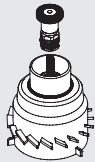

| Code    | Description        |
|---------|--------------------|
| 9210211 | Poppet FR 5µm SY1  |
| 9210212 | Poppet FR 20µm SY1 |
| 9210213 | Poppet FR 50µm SY1 |
| 9210231 | Poppet FR 5µm SY2  |
| 9210232 | Poppet FR 20µm SY2 |
| 9210233 | Poppet FR 50µm SY2 |

**CNOMO CONTROL FOR V3V AND APR SY2**

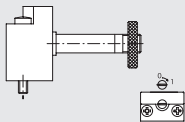

| Code    | Description                             |
|---------|---|
| 9453922 | Elpn Cnomo control kit, manual bistable |

**NOTES**

**UNITS**

Synthesis SPARE PARTS