

Service unit

Filter regulator + lubricator »SYNTESI« series

PLUS ||

Art. No. 144752

Type No. 5624B26L104



Exemplary illustration

Two-part service units consisting of filter regulator and lubricator of the »SYNTESI« series. For all information on the relevant properties, please refer to the data sheets of the individual components.

Pressure gauge not included in delivery!

Technical data

Series	Syntesi
Size	2
Max. input pressure	13 bar
Temperature range	-10 to 50 °C
Control range	0 - 12 bar
Input	G 1/2
Output	G 1/2
Front and back port thread	G 1/4
Flow rate measurement 1	at $P_1 = 10$ bar, $P_2 = 6.3$ bar and pressure drop $\Delta_p = 0.5$ bar
Flow rate 1	1200 NI/min
Flow rate measurement 2	at $P_1 = 10$ bar, $P_2 = 6.3$ bar and pressure drop $\Delta_p = 1$ bar
Flow rate 2	4000 NI/min
Filter rating	20 μ m
Condensate drain	RMSA semi-automatic
Output air purity class according to ISO 8573-1	4.7.-
Medium	Compressed air or other neutral gases
Housing	Technopolymer
Sealant	NBR
Diaphragms	NBR 60 Shore (hardness) with polyester fabric insert
Bowl	Technopolymer
Sight dome	Brass
Spring bonnet	Technopolymer
A	121.0 mm
A1	- mm
B	246.0 mm
N	139.8 mm

Commercial data

Customs tariff number	84811005
Country of origin	IT
eCl@ss 5.1.4	27292890
eCl@ss 9.0	27292890
UNSPSC_Code_v190501	27131604
UNSPSC_CodeDesc_v190501	Pneumatic lubricators

FR + LUB SYNTESI®



For full details and list of components refer to the sections about filter-regulator and the lubricator.



TECHNICAL DATA	FR + LUB SY1			FR + LUB SY2			
	1/8"	1/4"	3/8"	3/8"	1/2"	3/4"	1"
Threaded port	1/8" 1/4" 3/8" 3/8" 1/2" 3/4" 1"						
Degree of filtration	5 (yellow) - output air purity class ISO8573-1: 3.7.- 20 (white) - output air purity class ISO8573-1: 4.7.- 50 (blue) - output air purity class ISO8573-1: 5.7.-						
Max. inlet pressure	bar			bar			
	MPa			MPa			
	psi			psi			
Flow rate at 6.3 bar (0.63 MPa; 91 psi) ΔP 0.5 bar (0.05 MPa; 7 psi) (P In=10 bar)	NI/min			NI/min			
	scfm			scfm			
Flow rate at 6.3 bar (0.63 MPa; 91 psi) ΔP 1 bar (0.1 MPa; 14 psi) (P In=10 bar)	NI/min			NI/min			
	scfm			scfm			
Relief valve flow rate at 6.3 bar (0.63 MPa; 91 psi)	NI/min			NI/min			
	scfm			scfm			
Min/max temperature at 10 bar; 1 MPa; 145 psi	°C			°C			
Padlockable knob	Included						
Upstream pressure compensation	Included, via balanced valve						
Weight	g	414	409	400	1074	1047	1043 1031
Fluid	Compressed air or other inert gases						
Mounting position	Vertical			Vertical			
Additional air take-off, for pressure gauges or fittings	1/8", front and rear			1/4", front and rear			
Additional air take-off flow rate at 6.3 bar (0.63 MPa; 91 psi) ΔP 1 bar (0.1 MPa; 14 psi)	NI/min			NI/min			
	scfm			scfm			
Filter bowl capacity (condensate)	cm ³			cm ³			
Quantity of filled oil	cm ³			cm ³			
Condensate drain	RMSA: drain with manual condensate discharge and automatic discharge at zero pressure RA: automatic drain with condensate discharge, independent of pressure and flow rate. Version conveys the draining by inserting the pipe having internal diameter 6 mm in the lower port. SAC: automatic drain with condensate discharge. Operates by pressure drop - requires variable air take-offs. Note: the maximum input pressure for the RA version must not exceed 10 bar ISO and UNI FD22 (Energol HPL; Spinesso; Mobil DTE; Tellus oil)						
Recommended oils							
Wall fixing screws	No. 2 M4 screws			No. 2 M5 screws			

UNITS

FR + LUB Syntesi®

DIMENSIONS

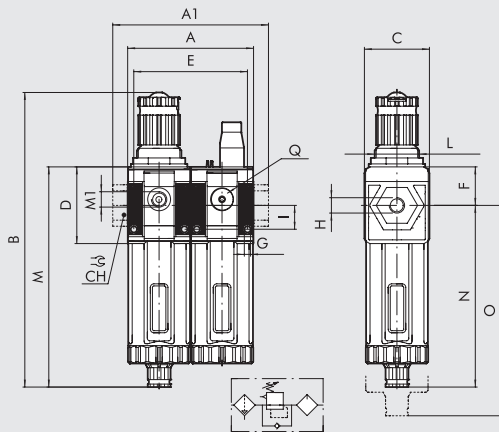

	SIZE 1			SIZE 2			
	1/8"	1/4"	3/8"	3/8"	1/2"	3/4"	1"
H (threaded port)	1/8"	1/4"	3/8"	3/8"	1/2"	3/4"	1"
A	84				121		
A1	-	-	86	-	-	156	156
B	RMSA			246			
	RA/SAC			250			
C	44			61			
CH	-			32 36			
D	51.5			70.5			
E	75.3			108			
F	25.8			38.2			
G	Hole for M4 screws			Hole for M5 screws			
I	16			22.5			
L	M30x1.5			M38x2			
M	RMSA			178			
	RA/SAC			182			
M1 (pressure gauge port)	1/8"			1/4"			
N	RMSA			139.8			
	RA/SAC			143.8			
O	RMSA			202			
	RA/SAC			249			
Q (no. 2 additional air takes-off)	1/8"			1/4"			

KEY TO CODES

56	1	1	B	24	L	10	1
SYNTESI	SIZE	THREADED INPUT CONNECTION	ELEMENT	DEGREE OF FILTRATION, TYPE OF CONDENSATE DRAIN AND SETTING RANGE	ELEMENT	OIL FILLING	THREADED OUTPUT CONNECTION
56 Syntesi 5X Syntesi anti-corrosion	1 Size 1 2 Size 2	1 1/8" port 2 1/4" port 3 3/8" port 4 1/2" port 5 3/4" port 6 1" port	B Filter-regulator	<ul style="list-style-type: none"> ● 10 5 µm, RMSA, 0 to 2 bar ● 20 20 µm, RMSA, 0 to 2 bar ● 30 50 µm, RMSA, 0 to 2 bar ● 40 5 µm, RA, 0 to 2 bar ● 50 20 µm, RA, 0 to 2 bar ● 60 50 µm, RA, 0 to 2 bar ● 11 5 µm, SAC, 0 to 2 bar ● 21 20 µm, SAC, 0 to 2 bar ● 31 50 µm, SAC, 0 to 2 bar + 12 5 µm, RMSA, 0 to 4 bar + 22 20 µm, RMSA, 0 to 4 bar + 32 50 µm, RMSA, 0 to 4 bar + 42 5 µm, RA, 0 to 4 bar + 52 20 µm, RA, 0 to 4 bar + 62 50 µm, RA, 0 to 4 bar + 13 5 µm, SAC, 0 to 4 bar + 23 20 µm, SAC, 0 to 4 bar + 33 50 µm, SAC, 0 to 4 bar 14 5 µm, RMSA, 0 to 8 bar 24 20 µm, RMSA, 0 to 8 bar 34 50 µm, RMSA, 0 to 8 bar 44 5 µm, RA, 0 to 8 bar 54 20 µm, RA, 0 to 8 bar 64 50 µm, RA, 0 to 8 bar 15 5 µm, SAC, 0 to 8 bar 25 20 µm, SAC, 0 to 8 bar 35 50 µm, SAC, 0 to 8 bar 16 5 µm, RMSA, 0 to 12 bar 26 20 µm, RMSA, 0 to 12 bar 36 50 µm, RMSA, 0 to 12 bar 46 5 µm, RA, 0 to 12 bar 56 20 µm, RA, 0 to 12 bar 66 50 µm, RA, 0 to 12 bar 17 5 µm, SAC, 0 to 12 bar 27 20 µm, SAC, 0 to 12 bar 37 50 µm, SAC, 0 to 12 bar 	L Lubricator	10 Manual filling from the top	1 1/8" port 2 1/4" port 3 3/8" port 4 1/2" port 5 3/4" port 6 1" port

● Not available in the anti-corrosion version.
 + Anti-corrosion version available only in size 1.

RMSA: drain with manual condensate discharge and automatic discharge at zero pressure
 RA: automatic drain with condensate discharge, independent of pressure and flow rate. Version conveys the draining by inserting the pipe having internal diameter 6 mm in the lower port.
 SAC: automatic drain with condensate discharge.
Operates by pressure drop – requires variable air take-offs.

UNITS

FR + LUB Syntesi®

PURCHASE ORDER CODES HAVING A MORE FREQUENT USE

N.B. Besides the below mentioned codes, you can order elements composed at your will according to the key to codes.

Code	Description	Code	Description	NOTE
FR + LUB Syntesi[®] SY1		FR + LUB Syntesi[®] SY2		
5611B24L101	FR+LUB SY1 1/8 20 08 RMSA	5623B24L103	FR+LUB SY2 3/8 20 08 RMSA	Anti-corrosion version
5611B54L101	FR+LUB SY1 1/8 20 08 RA	5623B54L103	FR+LUB SY2 3/8 20 08 RA	5X_-----
5612B24L102	FR+LUB SY1 1/4 20 08 RMSA	5624B24L104	FR+LUB SY2 1/2 20 08 RMSA	Example
5612B54L102	FR+LUB SY1 1/4 20 08 RA	5624B54L104	FR+LUB SY2 1/2 20 08 RA	5X11B54L101 FR+LUB SY1 1/8 20 08 RA anti-corrosion
5613B24L103	FR+LUB SY1 3/8 20 08 RMSA	5625B24L105	FR+LUB SY2 3/4 20 08 RMSA	
5613B54L103	FR+LUB SY1 3/8 20 08 RA	5625B54L105	FR+LUB SY2 3/4 20 08 RA	
		5626B24L106	FR+LUB SY2 1 20 08 RMSA	
		5626B54L106	FR+LUB SY2 1 20 08 RA	

NOTES
UNITS

FR + LUB Syntesi[®]

GENERAL TECHNICAL DATA SYNTESI®

Syntesi® is an important milestone achieved by Metal Work, the result of thirty years' experience producing air-treatment units. It has been studied in minute detail to obtain the best possible performance in a reduced space and with limited weight. The capacity is much higher than that of other units of the same size.

This modular unit features a very simple yet effective system that requires no brackets, stay bolts or yoke for assembling the elements.

The basic version of Syntesi® incorporates numerous functions that are not provided or are only optional with traditional units. Examples are padlockable knobs, additional pneumatic ports on the front and back, flow options from left to right or vice versa, regulators with compensation system - which are accurate even when the upstream pressure changes, with rapid downstream pressure relief - full indelible marking, automatic condensate drain even in size 1, and 360° visual inspection of oil and condensate levels. The basic materials, technopolymer and nickel-plated brass have excellent corrosion resistance. An anti-corrosion version is available with stainless steel components (screws, plates) or Geomet®-treated ones (regulator springs).



UNITS

GENERAL TECHNICAL DATA Syntesi®

TECHNICAL DATA	SIZE 1			SIZE 2			
	1/8"	1/4"	3/8"	3/8"	1/2"	3/4"	1"
Threaded port							
Max. input pressure	bar	15			13		
	MPa	1.5			1.3		
	psi	217			188		
Flow rate	See catalogue of the various elements						
Min/max temperature at 10 bar; 1 MPa; 145 psi	°C from -10 to +50			°C from -10 to +50			
Padlockable knob	The knobs of the regulators, filter regulators and standard sectioning valves can all be padlocked						
Fluid	Compressed air or other inert gases						
Mounting position	See catalogue of the various elements						
Direction of flow	Flow options right to left or vice versa						
Additional air take-off, for pressure gauges or fittings	1/8", front and rear, on all modules			1/4", front and rear, on all modules			
Wall fixing screws	No. 2 M4 screws			No. 2 M5 screws			
Certification for potentially explosive atmosphere according to ATEX 2014/34/EU rule	 II 3G Ex h IIC T5 Gc -10°C < Ta < 50°C II 3D Ex h IIIC T100 °C Dc						

ANTI-CORROSION VERSION

- Differences compared to the standard version:
- stainless steel screws
 - stainless steel plate for R, FR, V3V knobs
 - Geomet®-treated regulator spring and filter-regulator

FIXING TO FRONT PORTS



Do not use a spanner for fixing taper threaded elements to the front ports. Mount by hand and apply a liquid sealant (not teflon®).

ROTARY BUSHINGS



3/4" and 1" bushings in Size 2 rotate freely to facilitate assembly operations.

LASER MARKING



The following is marked indelibly on the body:

- Metal Work trademark
- Code
- Maximum pressure and temperature
- Degree of filtration or pressure range, where relevant
- Week and year of manufacture
- Atex category
- Made in Italy

MOUNTING OPTIONS

On the wall, using two screws



On a panel



Using knob bracket



Using a bracket



The bracket can be secured in any position, and the fittings can be mounted on the pressure gauge air intake at the back of the unit.

On a DIN EN50022 bar with the opposite adaptor



MODULARITY AND FLEXIBILITY

UNITS

GENERAL TECHNICAL DATA Syntesi®



The various elements of Syntesi® A can be connected to the air feed and delivery circuit using pneumatic nickel brass or passivated aluminium ports® and can be fixed together using nipples®.

The nipples and ports are easy to remove by unscrewing the two front screws®. This solution has numerous advantages:

- Reduced overall dimensions.
- Free composition of multiple elements, without the need for brackets, stay bolts or yoke.
- The threads for the fittings are metallic, allowing high tightening torques, also for tapered threads.
- Maximum flexibility: a unit can be transformed at any time by adding an element or replacing a port with another one, e.g. 1/4" instead of 1/8".
- The air intake port can be the same or different from the outlet port, as desired.

Standard Syntesi® ports are: 1/8", 1/4", 3/8" for size 1; 3/8", 1/2", 3/4", 1" for size 2.

It may be necessary to use a vice to insert the bushes into size 2.

The nipples have different functions:

- Nipple® joins two elements of the same size together.
- Size adaptor® can be used to connect an element in the Syntesi® 2 series with one in the Syntesi® 1 series.
- The 90° adaptor® can be used to connect two 90° angled elements. For example, it can help directing the regulator knob or the control knob of a sectioning valve towards the user.
- The two-way air intake® is a simple and cost-effective system which, besides connecting two elements together, has 2 opposing threaded air intakes.
- The adaptor for Regtronic® can be used to fix the Regtronic 1/4" proportional valve to a Syntesi® size 1 element.

Additional ports®. On the front and back of ALL Syntesi® elements there is a port (1/8" for size 1, 1/4" for size 2) that can be used for pressure gauges®, pressure switches® or, given the high flow rate, as additional air take-off®. These ports are downstream of the element, so, for example, a regulator port can supply air at a set pressure or a filter port can supply filtered air (not valid for activated carbon filter and depurator).

Wall fixing. Only two through screws® are needed. No bulky brackets or additional flanges are required. The bracket® can be used to separate the unit from the fixing wall, e.g. to mount a fitting to the rear port.

Fixing on a DIN EN50022 bar. Can be done using the bracket kit®.

Regulator fixing bracket®. Regulators and filter-regulators can also be fixed using a steel bracket® that embraces the bell.

Padlockable knob®. The knobs of regulators, filter-regulator and sectioning valves can all be padlocked. The steel plate is included in the supply. You can insert up to two 3 mm diameter padlocks® on size 1 and three padlocks on size 2. As an alternative, the sectioning valve can have a steel plate suitable for a single 6 mm diameter padlock.

Safety valve®. The unit can incorporate a series 70 SAFE AIR® safety valve.

Flowmeter series FLUX 1-2®. The unit can incorporate a series FLUX 1 or FLUX 2 flow meter.

C1

SYNTESI® KEY TO CODES

KEY TO CODES SINGLE ELEMENT

56	1	1	F	10	1
SYNTESI	SIZE	THREADED INPUT CONNECTION	ELEMENT	TYPE	THREADED OUTPUT CONNECTION
56 Syntesi 5X Syntesi anti-corrosion	1 Size 1	0 Without bushing 1 1/8" port 2 1/4" port 3 3/8" port	F Filter D Depurator C Active carbon filter R Pressure regulator B Filter-regulator L Lubricator ● V Shut off valve ▲ A Progressive starter ▲ S Pressure switches P Air take-off	Varies from element to element	0 Without bushing 1 1/8" port 2 1/4" port 3 3/8" port
	2 Size 2	0 Without bushing 3 3/8" port 4 1/2" port 5 3/4" port 6 1" port			0 Without bushing 3 3/8" port 4 1/2" port 5 3/4" port 6 1" port

- The anti-corrosion version of this element is only available with manual actuation.
- ▲ Not available in the anti-corrosion version.

KEY TO CODES UNIT COMPOSED OF TWO OR THREE ELEMENTS

56	1	1	V	10	B	24	L	10	1
SYNTESI	SIZE	THREADED INPUT CONNECTION	ELEMENT 1	TYPE	ELEMENT 2	TYPE	ELEMENT 3	TYPE	THREADED OUTPUT CONNECTION
56 Syntesi 5X Syntesi anti-corrosion	1 Size 1	1 1/8" port 2 1/4" port 3 3/8" port	F Filter D Depurator C Active carbon filter R Pressure regulator B Filter-regulator L Lubricator ● V Shut off valve ▲ A Progressive starter ▲ S Pressure switches P Air Take-off	Varies from element to element	F Filter D Depurator C Active carbon filter R Pressure regulator B Filter-regulator L Lubricator ● V Shut off valve ▲ A Progressive starter ▲ S Pressure switches P Air Take-off	Varies from element to element	F Filter D Depurator C Active carbon filter R Pressure regulator B Filter-regulator L Lubricator ● V Shut off valve ▲ A Progressive starter ▲ S Pressure switches P Air Take-off	Varies from element to element	1 1/8" port 2 1/4" port 3 3/8" port 3 3/8" port 4 1/2" port 5 3/4" port 6 1" port
	2 Size 2	3 3/8" port 4 1/2" port 5 3/4" port 6 1" port							

- The anti-corrosion version of this element is only available with manual actuation.
- ▲ Not available in the anti-corrosion version.

UNITS

SYNTESI® KEY TO CODES

C1.8

Accessories

	Art. No.	Type No.
Bowl, size 2, RA fully automated	145615	9210106
Bowl, size 2, SAC fully automated	145616	9210107
Filter element, size 2, 5 µm	145622	9210155
Filter element, size 2, 50 µm	145624	9210157
Valve poppet for filter regulator, size 2, 5 µm	145654	9210231
Valve poppet for filter regulator, size 2, 50 µm	145656	9210233
Mounting bracket, size 2, standard and anti-corr.	145659	9200717X
Adapter for DIN rail, size 1 and size 2	145660	9200718X
Pressure gauge, G1/4 rear centric, 0-12 bar, Ø63mm	145474	9900101
Adapter for pressure gauges, G 1/4 ET, G 1/8 IT	145477	9210005
Connecting nipple kit, size 2	144696	9210010
Connecting element 90°, size 2	145503	9210019
Size adapter, size 1 - size 2, incl. 4 screws	145504	9210006
Assembly key for bowl, size 2	145506	9210050
Fastening screw, size 2	145508	9210031
Padlock	145509	9062401

Spareparts

	Art. No.	Type No.
Bowl, size 2, RMSA semi-automated	145614	9210105
Bowl for lubricator, size 2, PA12	145618	9210115
Filter element, size 2, 20 µm	145623	9210156
Lubricator dome (drip cap), s2, w. oil filling cap	145630	9210185
Oil filling cap, size 2	145632	9210186
Spring, size 2, 0 - 12 bar	145640	9210198
Regulator cap (bell), size 2, 0 - 12 bar	145648	9210223
Valve poppet for filter regulator, size 2, 20 µm	145655	9210232
Threaded port bushing, size 2, G 1/2	144692	9210012