

Push-in T-fitting

stainless steel

STAINLESS STEEL

Art. No. 135213

Type No. 871.014-4 ES

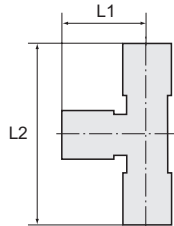

Exemplary illustration

For use in more aggressive environments and corrosive media.
The suitability test for the individual application is the user's responsibility.

Technical data

Working pressure	-0.98 - 20 bar
Operating temperature	-20 to 150 °C
Medium temperature	-20 to 150 °C
Material	Stainless steel 1.4404
Medium	Compressed air,corrosive media (if compatible with material)
Sealant	FPM
Applications	Compressed air syst.,chemical and food, pharma, pack.,vacuum
Thread form	Parallel male thread
Standard thread	DIN EN ISO 228-1
Version	Angled plug connections, with o-ring (FPM)
Design	Swivel type
Thread	G 1/4
For tube O.D.	4 mm
L1	20.3 mm
L2	47.1 mm
a/f	17 mm
a/f 1	10 mm
Suitable pipe materials	PVDF, PTFE, PA, PU

The suitability test for the use with alternative specifications is the user's responsibility.

Commercial data

Customs tariff number	73072910
Country of origin	IN
eCl@ss 5.1.4	27294201
eCl@ss 9.0	27294201
UNSPSC_Code_v190501	27131613
UNSPSC_CodeDesc_v190501	Air coupling

Material informations

REACH SVHC1 substance name	no
CAS no. SVHC 1	no CAS No.
RoHS materials notice	RoHS compliant
REACH Info	no SVHC substance included

Dimensions

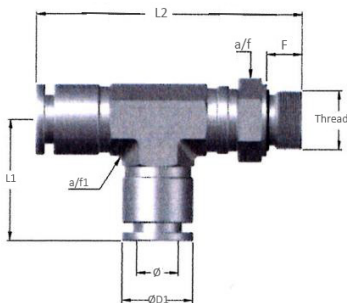

Thread	Standard thread	For tube O.D.	F	a/f	a/f 1	L1	L2	D1
		mm	mm	mm	mm	mm	mm	mm
G 1/4	DIN EN ISO 228-1	4	7.5	17	10	20.3	47.1	10.0

Accessories

	Art. No.	Type No.
Loosening tool, quick-connect fittings, hose exterior Ø 3 - 10 mm	108853	LW3-10
Loosening tool, quick-connect fittings, hose exterior Ø 4-14 mm	121863	LW4-14