

Push-in T-fitting

»NonPlusUltra«

STAINLESS STEEL

Art. No. 131595

Type No. 855.038-10 ES FDA

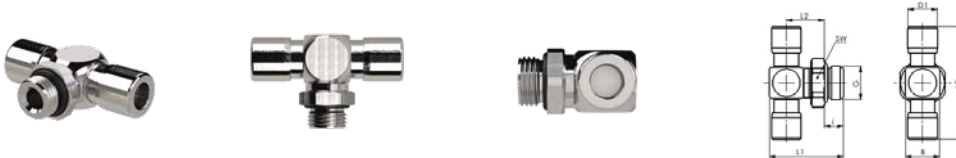

Exemplary illustration

The "NonPlusUltra" series combines excellent material quality with the best workmanship. All components are characterized by maximum tightness and optimized flow. Made entirely of corrosion-free and acid-resistant stainless steel with a surface roughness (Ra) < 0.8, they are extremely robust and easy to clean (can also be sterilized). Movable fittings are suitable for continuous movement due to a special swivel mechanism.

The stainless steel unions have a wide range of applications, for example in process engineering, food and pharmaceutical industries, water-cooling, lubrication, gases, vacuum and clean room (suitable cleaning of the parts is the responsibility of the user).

They are ideal for use in conjunction with our PUR hoses for food contact (FDA).

Available on request with EPDM seals, EPDM seals with drinking water approval, suitable for cleanroom class 3 according to DIN EN ISO 14644-1 and with colored ceramic coding.

Technical data

| | |
|--|--|
| Working pressure | max. bar |
| Operating temperature | -20 to 150 °C |
| Medium temperature | -20 to 150 °C |
| Working pressure compressed air and neutral gases max. | 16 bar |
| Working pressure liquids, oil, grease max. | 80 bar |
| Series | NonPlusUltra |
| Material | Stainless steel 1.4404 |
| Medium | Compressed air, neutral gases and liquids, oil, grease |
| Sealant | FPM (FDA compliant) |
| Standard thread | DIN ISO 228-1 |
| Thread | G 3/8 |
| For tube O.D. | 10 mm |
| L1 | 34.8 mm |
| L2 | 27.3 mm |
| L3 | 57.4 mm |
| i | 7.5 |
| B | 18.0 mm |
| D1 | 16.5 mm |
| a/f | 22 mm |
| Suitable pipe materials | PE, PA, PU, PTFE, FEP, Pipes |

Commercial data

| | |
|-------------------------|--------------|
| Customs tariff number | 73072910 |
| Country of origin | DE |
| eCl@ss 5.1.4 | 27294201 |
| eCl@ss 9.0 | 27294201 |
| UNSPSC_Code_v190501 | 27131613 |
| UNSPSC_CodeDesc_v190501 | Air coupling |

Material informations

| | |
|----------------------------|----------------------------|
| REACH SVHC1 substance name | no |
| CAS no. SVHC 1 | no CAS No. |
| RoHS materials notice | RoHS compliant |
| REACH Info | no SVHC substance included |

Insertion depth of tube

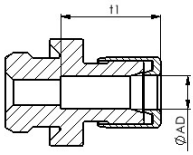

| For tube O.D. | t1 |
|---------------|-------------|
| 4 mm | ca. 12.3 mm |
| 6 mm | ca. 15 mm |
| 8 mm | ca. 18 mm |
| 10 mm | ca. 20.3 mm |
| 12 mm | ca. 25.3 mm |
| 14 mm | ca. 28.2 mm |
| 16 mm | ca. 31.3 mm |
| 20 mm | ca. 44 mm |

Materials/Construction

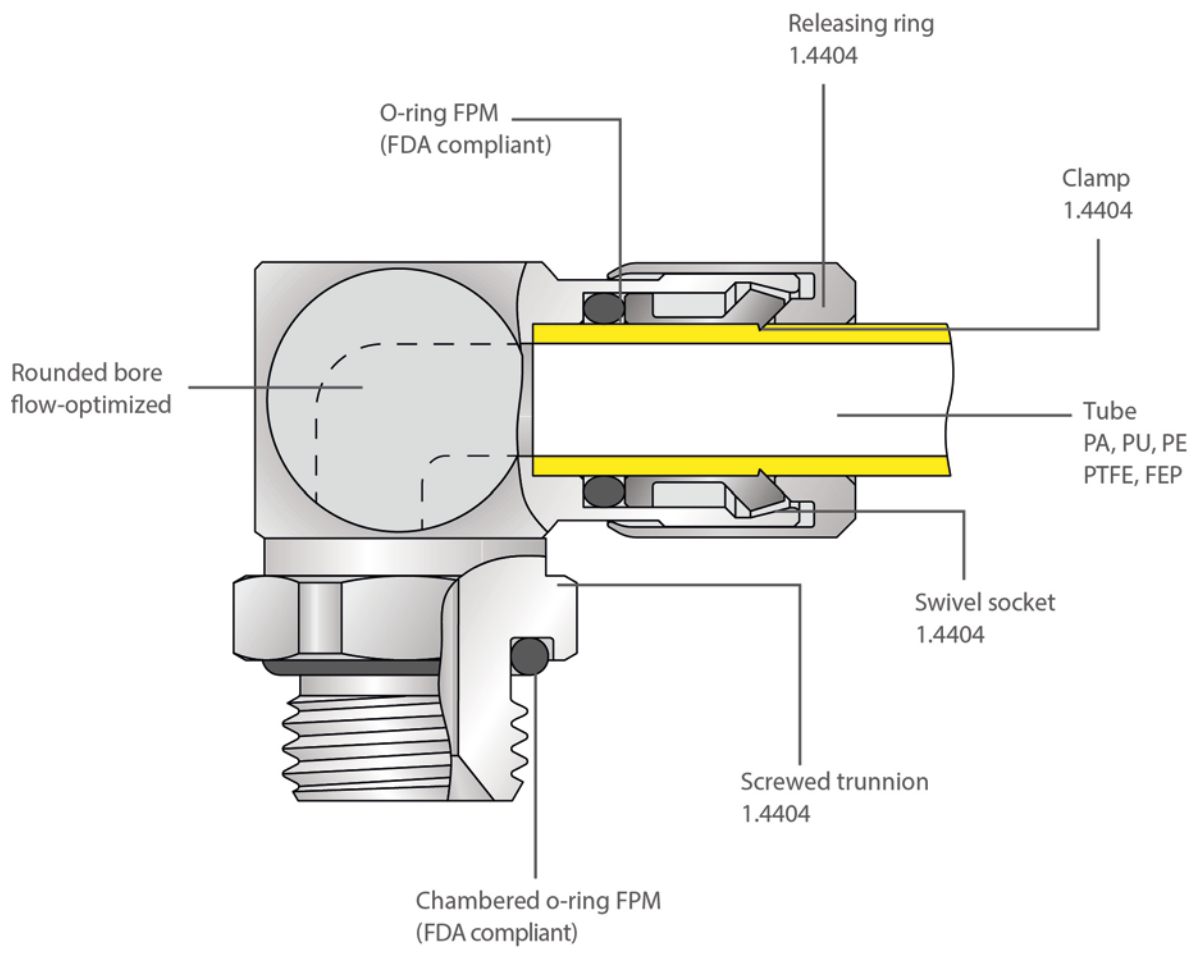

Ceramic colour coding on request.

