

Straight push-in fitting

»NonPlusUltra«

STAINLESS STEEL

Art. No. 130886

Type No. 844.012-14 ES FDA



Exemplary illustration

The »NonPlusUltra« series combines excellent material quality with the best workmanship. All components are characterized by maximum tightness and optimized flow. Made entirely of corrosion-free and acid-resistant stainless steel with a surface roughness (Ra) < 0.8, they are extremely robust and easy to clean (can also be sterilized). Movable fittings are suitable for continuous movement due to a special swivel mechanism.

The stainless steel unions have a wide range of applications, for example in process engineering, food and pharmaceutical industries, water-cooling, lubrication, gases, vacuum and clean room (suitable cleaning of the parts is the responsibility of the user).

They are ideal for use in conjunction with our PUR hoses for food contact (FDA).

Available on request with EPDM seals, EPDM seals with drinking water approval, suitable for cleanroom class 3 according to DIN EN ISO 14644-1 and with colored ceramic coding.

Technical data

Working pressure	max. bar
Operating temperature	-20 to 150 °C
Medium temperature	-20 to 150 °C
Working pressure compressed air and neutral gases max.	16 bar
Working pressure liquids, oil, grease max.	40 bar
Series	NonPlusUltra
Material	Stainless steel 1.4404
Medium	Compressed air, neutral gases and liquids, oil, grease
Sealant	FPM (FDA compliant)
Standard thread	DIN ISO 228-1
Thread	G 1/2
For tube O.D.	14 mm
L1	41.5 mm
L2	9.5 mm
D1	22.0 mm
DN	11
a/f	24 mm
Suitable pipe materials	PE, PA, PU, PTFE, FEP, Pipes

Commercial data

Customs tariff number	73072910
Country of origin	DE
eCl@ss 5.1.4	27294201
eCl@ss 9.0	27294201
UNSPSC_Code_v190501	27131613
UNSPSC_CodeDesc_v190501	Air coupling

Material informations

REACH SVHC1 substance name	no
CAS no. SVHC 1	no CAS No.
RoHS materials notice	RoHS compliant
REACH Info	no SVHC substance included

Insertion depth of tube



For tube O.D. **t1**

4 mm	ca. 12.3 mm
6 mm	ca. 15 mm
8 mm	ca. 18 mm
10 mm	ca. 20.3 mm
12 mm	ca. 25.3 mm
14 mm	ca. 28.2 mm
16 mm	ca. 31.3 mm
20 mm	ca. 44 mm

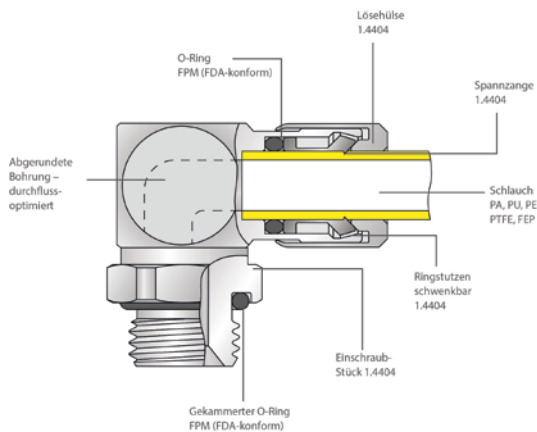

Materials/Construction



Ceramic colour coding on request.

