

Sintered bronze silencer

PLUS

Art. No. 113338

Type No. 567-1

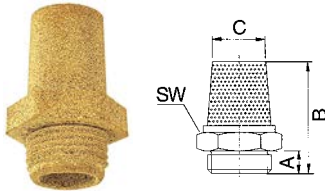

Exemplary illustration

For reducing the exhaust noise generated by pneumatic equipment.

Technical data

Operating pressure	0 - 8 bar
Operating temperature	-10 to 250 °C
Material	Sintered bronze
Max. pore size	50 µm
Version	with hexagon nut
Thread	G 1/8
a/f	13 mm
A	6.0 mm
B	28.0 mm
C	8.0 mm
Noise reduction	≥ 20 dB(A)
Noise level at 6 bar	71 to 108 dB
Flow rate at 6 bar	1200 l/min

Flow rate measurement at 6 bar, differential pressure Δp 1 bar in atmosphere

The use of silencers does not automatically reduce exhaust noise to a safe level. The need for other noise-reducing measures, such as hearing protection, must be assessed as well.

Uses and applications are the responsibility of the user. However, it is necessary to carry out appropriate tests before use in order to convince yourself of the desired function under the respective conditions. All further claims, in particular liability for consequential damages, are excluded in principle.

Commercial data

Customs tariff number	84819000
Country of origin	CN
eCl@ss 5.1.4	27299223
eCl@ss 9.0	27299223
UNSPSC_Code_v190501	27131609
UNSPSC_CodeDesc_v190501	Pneumatic silencers

Material informations

REACH SVHC1 substance name	lead
CAS no. SVHC 1	7439-92-1
RoHS materials notice	RoHS compliant
REACH Info	contains SVHC substance

Noise level at 6 bar

<dB1	<dB2	≥ΔdB
110.6	73.2	37.4

dB1	Noise level without silencer
dB2	Noise level with silencer
ΔdB	Noise reduction

Dimensions

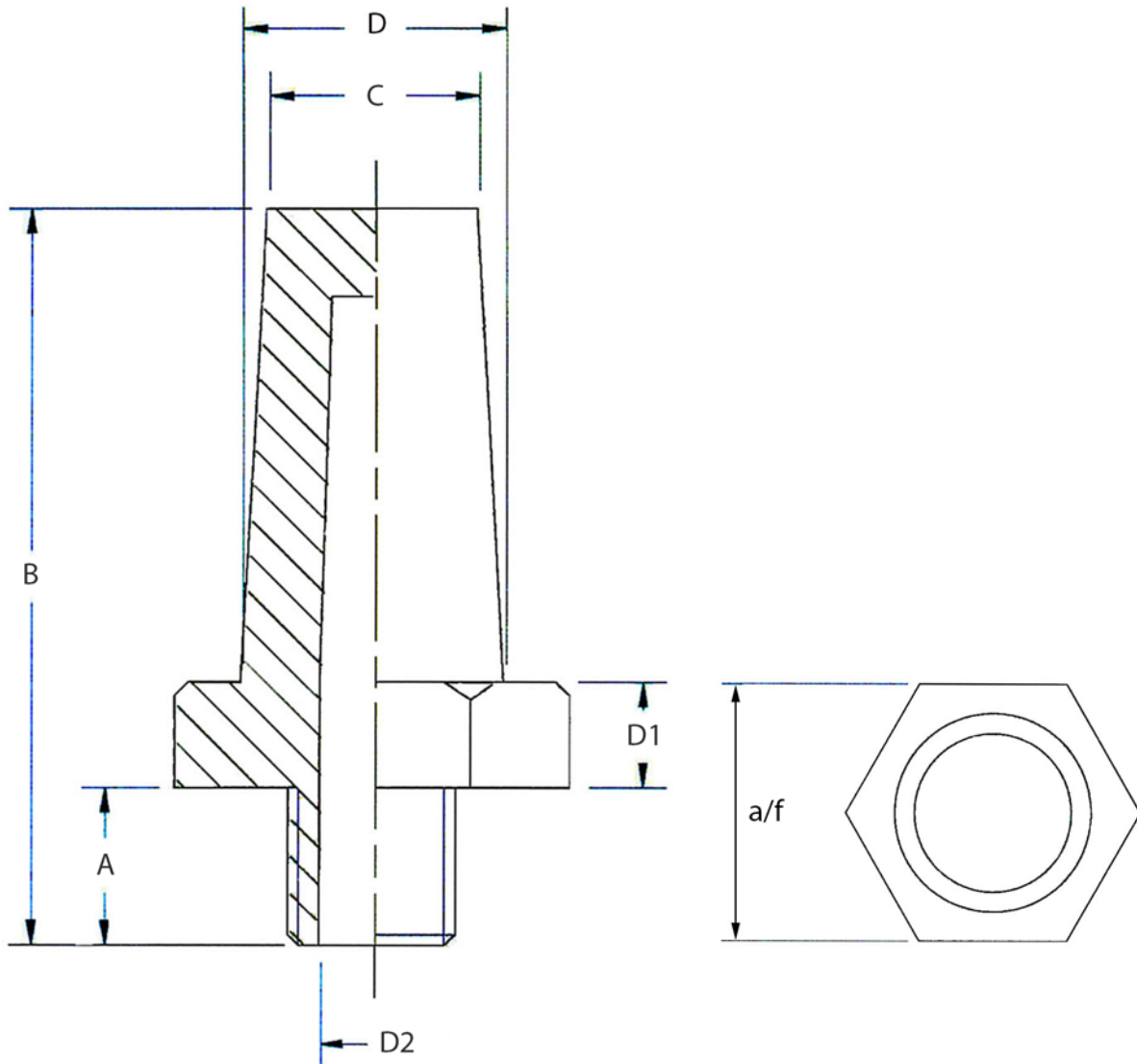

Thread	A mm	B mm	C mm	a/f mm	D2 mm	D mm	D1 mm
G 1/8	6.0	28.0	8.0	13	4.0	10.0	4.0