

Distributor

PLUS

Art. No. 112598

Type No. 255.038

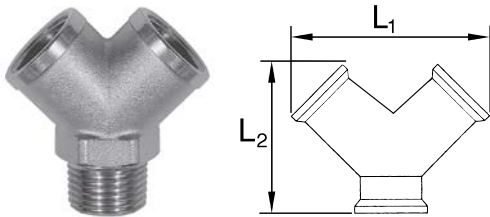

Exemplary illustration

Technical data

Max. operating pressure	60 bar
Max. temperature range	150 °C
Material	nickel-plated brass
Inlet thread	R 3/8 ET
Connection	2
Connecting thread	G 3/8 IT
L1	41.0 mm
L2	42.5 mm
a/f	20 mm

Commercial data

Customs tariff number	74122000
Country of origin	IT
eCl@ss 5.1.4	27294206
eCl@ss 9.0	27294206
UNSPSC_Code_v190501	27131601
UNSPSC_CodeDesc_v190501	Air manifolds

Material informations

REACH SVHC1 substance name	lead
CAS no. SVHC 1	7439-92-1
RoHS materials notice	RoHS compliant
REACH Info	contains SVHC substance

Dimensions

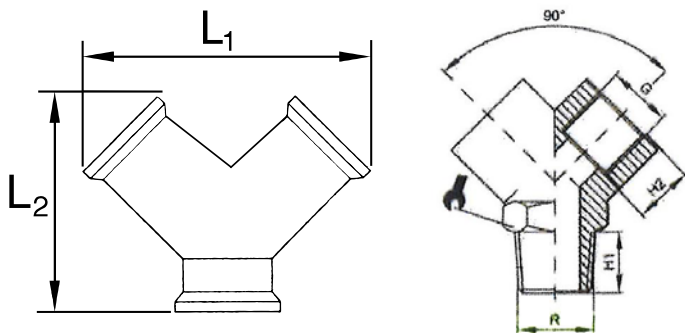

L1	L2	H1	H2	a/f
mm	mm	mm	mm	mm
41.0	42.5	11.5	11.5	20

Applications

Pneumatic, oil hydraulic and hydraulic circuits.