

Multi-base plate

for the pilot valves, pneumatic and electro-pneumatic

Art. No. 106633

Type No. 520.03-14



Exemplary illustration

Light alloy manifold bases for 2 to 10 valve positions.
Not for 5/2-way spool valves - Robust type and 3A, 4A, 3V, 4V type.

Technical data

Description	Manifold base for 3 valve positions
Version	with 9 screws and gaskets

Commercial data

Customs tariff number	84818099
Country of origin	IT
eCl@ss 5.1.4	27299205
eCl@ss 9.0	27299205
UNSPSC_Code_v190501	40141616
UNSPSC_CodeDesc_v190501	Valve parts or accessories

Material informations

REACH SVHC1 substance name	no
CAS no. SVHC 1	keine CAS Nr.
RoHS materials notice	RoHS konform
REACH Info	kein SVHC Stoff enthalten

ACCESSORIES: 1/8 MANIFOLDS FOR SERIES 70 PNV-SOV AND SERIES BASIC VALVES

MANIFOLD WITH 2 TO 7 POSITIONS + FITTINGS

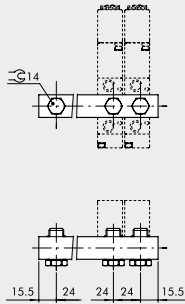

Code	Description	Weight [g]
0221000200	CSA-18-02	70
0221000300	CSA-18-03	99
0221000400	CSA-18-04	131
0221000500	CSA-18-05	162
0221000600	CSA-18-06	192
0221000700	CSA-18-07	229

BRACKET SET H120

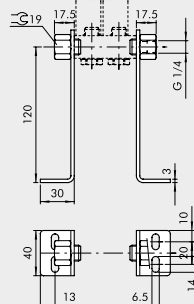

Code	Description	Weight [g]
0221000190	CSA-18-OO	309

BRACKET SET H60

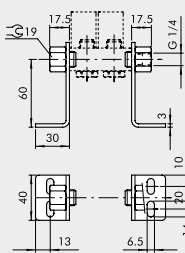

Code	Description	Weight [g]
0221000191	CSA-18-OC	213

BRACKET SET H30

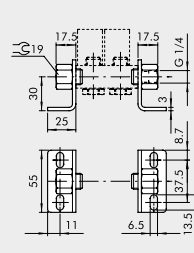

Code	Description	Weight [g]
0221000192	CSA-18-OE	181

VALVES

ACCESSORIES FOR VALVES SERIES 70

ACCESSORIES: 1/4 MANIFOLDS FOR SERIES 70 PNV-SOV AND SERIES BASIC VALVES

MANIFOLD WITH 2 TO 7 POSITIONS + FITTINGS

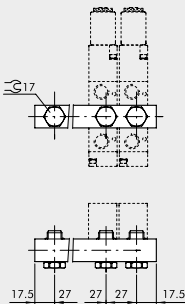

Code	Description	Weight [g]
0222000200	CSA-14-02	89
0222000300	CSA-14-03	131
0222000400	CSA-14-04	174
0222000500	CSA-14-05	213
0222000600	CSA-14-06	252
0222000700	CSA-14-07	328

BRACKET SET H120

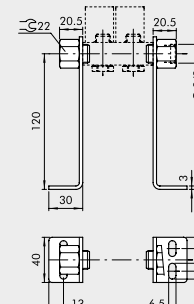

Code	Description	Weight [g]
0222000190	CSA-14-OO	338

BRACKET SET H60

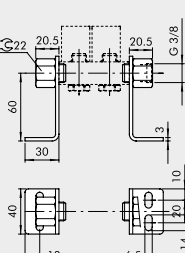

Code	Description	Weight [g]
0222000191	CSA-14-OC	242

BRACKET SET H30

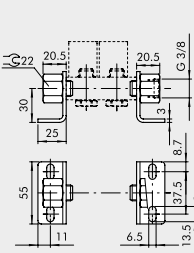

Code	Description	Weight [g]
0222000192	CSA-14-OE	209

ACCESSORIES: MANIFOLD BASES FOR SERIES 70 PNV-SOV AND SERIES BASIC VALVES

MODULAR BASES FOR SERIES 70 SOV-PNV VALVES

VALVES

ACCESSORIES FOR VALVES SERIES 70

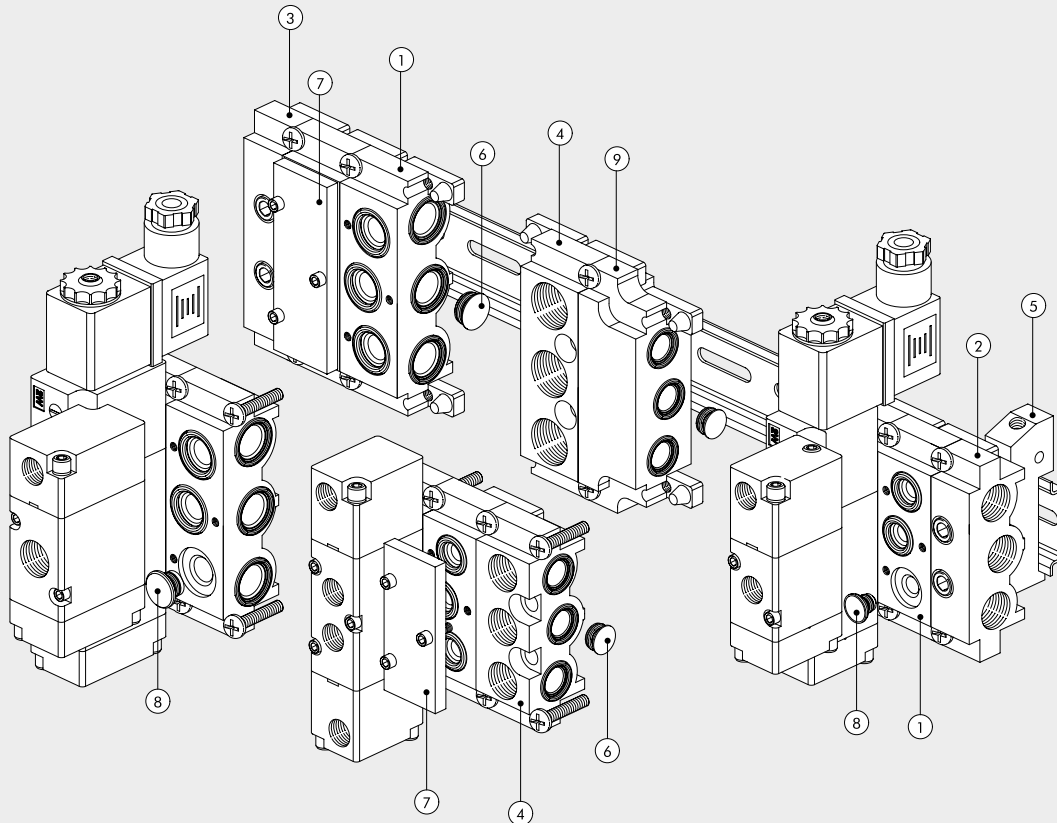

Reference	1/8"	1/4"	Description
①	0226004150	0226005150	Modular manifold base
②	0226004201	0226005201	End plate without OR
③	0226004200	0226005200	End plate with OR
④	0226004300	0226005300	Intermediate part for upper feed
⑤	0226004600	0226005600	Adapter for omega bar
⑥	0226004000	0226005000	Intermediate diaphragm
⑦	0226004500	0226005500	Blanking plate
⑧	0226004001	0226005001	3/2 cap
⑨	0226006600	-	Dimensional adapter

① MODULAR BASE MANIFOLD

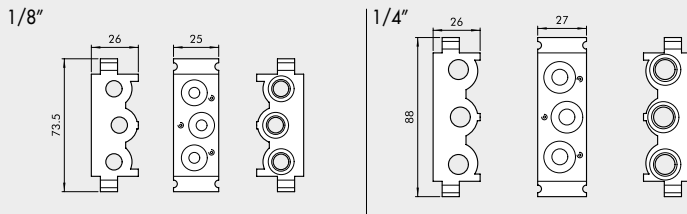

Code	Description	Weight [g]
0226004150	Modular base MANIFOLD 1/8"	110
0226005150	Modular base MANIFOLD 1/4"	131

② END PLATE WITHOUT OR

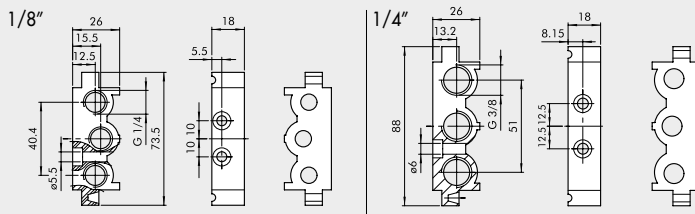

Code	Description	Weight [g]
0226004201	End plate without OR 1/8"	52
0226005201	End plate without OR 1/4"	57

③ END PLATE WITH OR

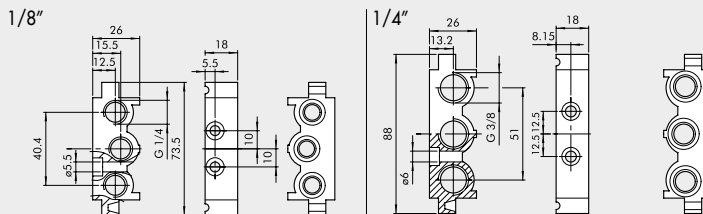

Code	Description	Weight [g]
0226004200	End plate with OR 1/8"	74
0226005200	End plate with OR 1/4"	80

④ INTERMEDIATE PART FOR UPPER FEED

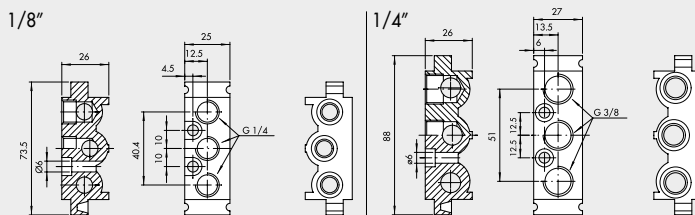

Code	Description	Weight [g]
0226004300	Intermediate part for upper feed 1/8"	93
0226005300	Intermediate part for upper feed 1/4"	109

⑤ ADAPTER FOR OMEGA BAR BASES (DIN EN 50022)

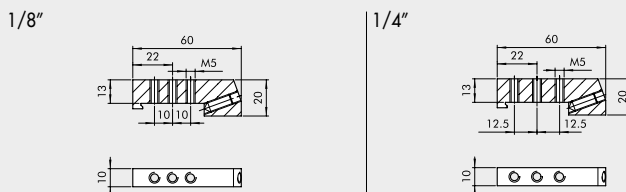

Code	Description	Weight [g]
0226004600	Adapter 1/8"	46
0226005600	Adapter 1/4"	46

N.B.: Also for multiple bases

VALVES

ACCESSORIES FOR VALVES SERIES 70

⑥ INTERMEDIATE DIAPHRAM

1/8"

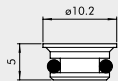

1/4"

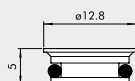

Code	Description	Weight [g]
0226004000	Intermediate diaphragm 1/8"	2
0226005000	Intermediate diaphragm 1/4"	3

⑦ BLANKING PLATE FOR UNUSED POSITIONS

1/8"

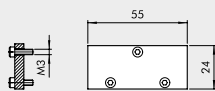

1/4"

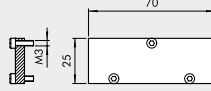

Code	Description	Weight [g]
0226004500	Blanking plate 1/8"	23
0226005500	Blanking plate 1/4"	29

⑧ PLUG FOR 3/2

1/8"

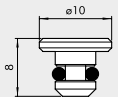

1/4"

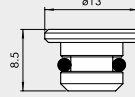

Code	Description	Weight [g]
0226004001	Blanking plate 3/2 1/8"	2
0226005001	Blanking plate 3/2 1/4"	4

⑨ DIMENSIONAL ADAPTER 1/8" - 1/4"

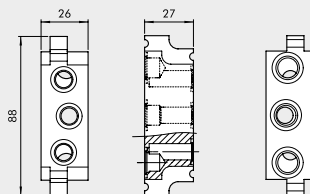

Code	Description	Weight [g]
0226006600	Adapter 1/8", 1/4"	177

NOTES

ACCESSORIES: MULTIPLE BASES FOR SERIES 70 PNV-SOV VALVES

MULTIPLE BASE 1/8"



Code	Description	Abbrev.	Weight [g]
0223000201	2-position base	CVM-18-02	236
0223000301	3-position base	CVM-18-03	321
0223000401	4-position base	CVM-18-04	407
0223000501	5-position base	CVM-18-05	494
0223000601	6-position base	CVM-18-06	587
0223000701	7-position base	CVM-18-07	711
0223000801	8-position base	CVM-18-08	760
0223000901	9-position base	CVM-18-09	842
0223001001	10-position base	CVM-18-10	923

MULTIPLE BASE 1/4"

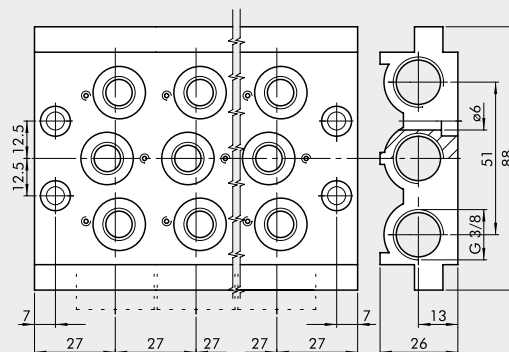

Code	Description	Abbrev.	Weight [g]
0224000201	2-position base	CVM-14-02	296
0224000301	3-position base	CVM-14-03	406
0224000401	4-position base	CVM-14-04	515
0224000501	5-position base	CVM-14-05	624
0224000601	6-position base	CVM-14-06	733
0224000701	7-position base	CVM-14-07	845
0224000801	8-position base	CVM-14-08	956
0224000901	9-position base	CVM-14-09	1055
0224001001	10-position base	CVM-14-10	1086

GASKET KIT

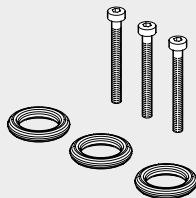

Code	Description	Weight [g]
0226004701	Gasket kit for 1/8" base	5
0226005701	Gasket kit for 1/4" base	5

VALVES

ACCESSORIES FOR VALVES SERIES 70

Accessories

	Art. No.	Type No.
Blanking plate G 3/8 manifold base for G 1/4 conn. surface	106641	520.14-A
Plugs for multiple manifold base, G 1/4	119136	520.14-V
Intermediate plugs for multiple manifold base, G 1/4	129153	520.14-Z
Omega adapter f. manifold base system/multi-base pl., G 1/4	146743	0226005600

Spareparts

	Art. No.	Type No.
Set of gasket (parts subject to wear), G 1/4	129903	520.14-DS