

# 5/3-way valve

pneumatic

**PLUS**

Art. No. 106518

Type No. 516.602

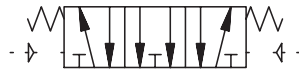

Exemplary illustration

Traditional way valves of series 70 in pneumatic version. These valves have a wide range of applications as bushing valves, direct mounting on the cylinder with special adapters or as series valves with multi-base plates and individual interlinking plates (supply strips).

## Technical data

Operating pressure	Vacuum to 10 bar
Temperature range	-10 to 60 °C
Pilot pressure	2.5 - 10 bar
Medium	Filtered compressed air with or without lubrication. If lubricated, then continuous.
Sealant	NBR
Flow rate measurement 1	Flow rate at 6 bar and $\Delta p$ 0.5 bar
Flow rate 1	3200 NI/min
Flow rate measurement 2	Flow rate at 6 bar and $\Delta p$ 1.0 bar
Flow rate 2	4600 NI/min
Connection	G 1/2
DN	15
Function	5/3
Operation	Mid-position exhausted
Symbol	30
Series	Valves series 70

## Commercial data

---

Customs tariff number	84818079
Country of origin	IT
eCl@ss 5.1.4	27291501
eCl@ss 9.0	27291390
UNSPSC_Code_v190501	40141603
UNSPSC_CodeDesc_v190501	Pneumatic valves

---

## VALVES SERIES 70

The Series 70 forms part of Metal Work's full range of traditional valves.  
They are available in sizes 1/8", 1/4", 3/8" and 1/2", versions 3/2, 5/2, 5/3 and double 3/2, with mechanical, manual, pneumatic and electric drives.  
They can be installed in line, onto a wall, on the cylinder (using a special bracket) or in series (on a multiple or modular base) to suit all possible applications.

A range of valves (Series 70 LT) designed using components for specific low-temperature applications is now available for the most commonly used types and sizes.

These highly reliable valves comply with the main applicable standards, including Atex, ISO 13489 and SIL, as stated in the documents and certificates available online.



TECHNICAL DATA	1/8"	1/4"	3/8"	1/2"	
Thread on the valve ports	1/8"	1/4"	3/8"	1/2"	
Operating pressure series 70 versions	bar				
monostable and bistable differential	2.5 to 10				
bistable	1 to 10				
asserved	vacuum to 10				
Operating pressure series 70 LT (low temperature) versions	bar				
hand operated	vacuum to 10				
pneumatic and solenoid/pneumatic	-				
t = -40°C to -10°C	5 to 10				
t = -10°C to +60°C	3 to 10				
Minimum pilot pressure	bar				
Operating temperature range	°C				
series 70 versions	-10 to +60				
series 70 LT (low temperature) versions	-40 to +60				
Nominal diameter	mm	5	7.5	13.3	15
Conductance C	Nl/min · bar	121.43	264.26	505.52	971.43
Critical ratio b	bar/bar	0.32	0.27	0.32	0.43
Flow rate at 6 bar ΔP 0.5 bar	Nl/min	400	750	1560	3200
Flow rate at 6 bar ΔP 1 bar	Nl/min	550	1100	2150	4600
Installation	In any position (vertical assembly is not recommended for bistable valves subjected to vibration)				
Fluid	Filtered air without lubrication; lubrication, if used, must be continuous.				
Recommended lubricant	For series 70 LT (low-temperature) versions, it is recommended to use of perferamente dried air. ISO and UNI FD 22				
Maximum coil nut torque	Nm				
Compatibility with oils	For series 70 LT (low-temperature) it is not expected to be used with lubricated air. 1 See chapter Z1				

### COMPONENTS SERIES 70

- ① VALVE BODY: Aluminium
- ② CONTROL/END CAP: plastic
- ③ SPOOL: chemically nickel-plated aluminium
- ④ DISTANCE PLATES: plastic
- ⑤ GASKETS: NBR
- ⑥ PISTONS: Hostaform®
- ⑦ PISTON GASKET: NBR
- ⑧ FILTER: plastic
- ⑨ SPRINGS: special steel
- ⑩ OPERATOR: Brass pipe - Stainless steel core

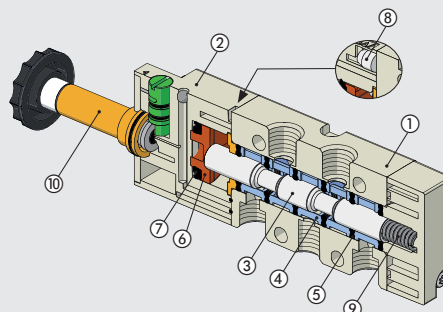

**COMPONENTS SERIES 70 LT (LOW TEMPERATURE)**

- ① ALVE BODY: aluminium
- ② CONTROL/END CAP: aluminium
- ③ SPOOL: chemically nickel-plated aluminium
- ④ DISTANCE PLATES: plastic
- ⑤ GASKETS: HNBR
- ⑥ PISTONS: aluminium
- ⑦ PISTON GASKET: HNBR
- ⑧ FILTER: plastic
- ⑨ SPRINGS: special steel
- ⑩ OPERATOR: brass pipe - Stainless steel core  
(version specific for low-temperature applications)

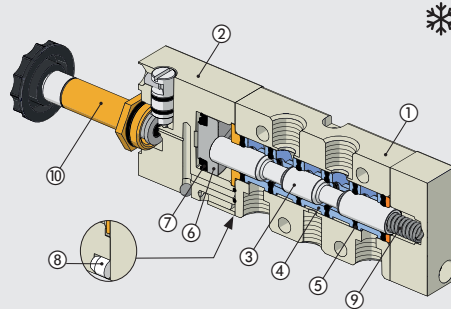

VALVES

VALVES SERIES 70

**FLOW CHARTS**

**VALVES SERIES 70 1/8"**

Flow rates

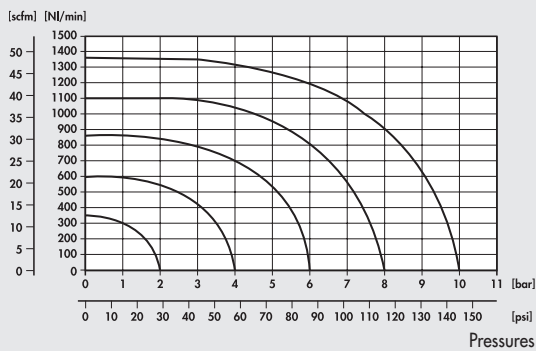

**VALVES SERIES 70 1/4"**

Flow rates



**VALVES SERIES 70 3/8"**

Flow rates

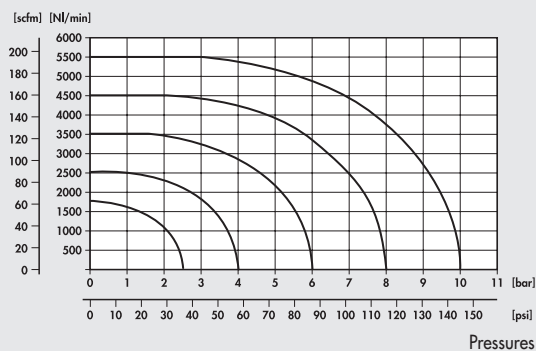

**VALVES SERIES 70 1/2"**

Flow rates





**VALVES SERIES 70, PNEUMATIC**

TECHNICAL DATA		1/8"	1/4"	3/8"	1/2"
Operating pressure	bar	Vacuum to 10			
Minimum pilot pressure					
• monostable and bistable differential	bar	2.5			
• bistable	bar	1			
Operating temperature range	°C	-10 to +60			
Nominal diameter	mm	5	7.5	13.3	15
Conductance C	NI/min · bar	121.43	264.26	505.52	971.43
Critical ratio b	bar/bar	0.32	0.27	0.32	0.43
Flow rate at 6 bar ΔP 0.5 bar	NI/min	400	750	1560	3200
Flow rate at 6 bar ΔP 1 bar	NI/min	550	1100	2150	4600
TRA / TRR monostable at 6 bar	ms	6/15	7/15	5/28	16/80
TRA / TRR bistable at 6 bar	ms	7/7	7/7	13/13	25/25



VALVES

VALVES SERIES 70, PNEUMATIC

**SYNOPTIC, SIZES AND VERSIONS**

PNV FAMILY	2 DIMENSIONS	3 FUNCTION	PN OPERATORS 14	S RESETTING (12)	NC FURTHER DETAILS
PNV pneumatic valves	2 1/8" 3 1/4" C 3/8" 4 1/2"	3 3/2 5 5/2 6 5/3 ■ 8 2-3/2	PN pneumatic	S mechanical springs B bistable D differential O stable for 5/3 ◆ A pneumatic/mechanical spring	OO no indication NC normally closed NO normally open CC closed centres OC open centres PC pressure centres ▲ NC-NO normally closed - normally open

- Only available for size 1/8" and 1/4"
- ◆ On demand
- ▲ Only available for function 2-3/2

**VALVES SERIES 70, PNEUMATIC, 1/8"**

**MONOSTABLE 3/2 NO, 1/8"**

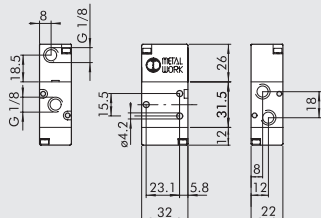

**MONOSTABLE 3/2 NC, 1/8"**

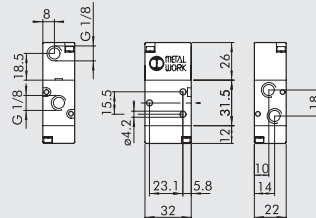

Symbol	Code	Abbrev.	Weight [g]
	7010010400	PNV 23 PNS NO	82

Symbol	Code	Abbrev.	Weight [g]
	7010010200	PNV 23 PNS NC	82





**VALVES SERIES 70, PNEUMATIC, 1/4"**

**MONOSTABLE 3/2 NO, 1/4"**

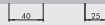

Symbol	Code	Abbrev.	Weight [g]
	7020010400	PNV 33 PNS NO	124

**MONOSTABLE 3/2 NC, 1/4"**

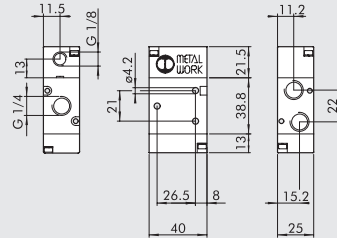

Symbol	Code	Abbrev.	Weight [g]
	7020010200	PNV 33 PNS NC	122

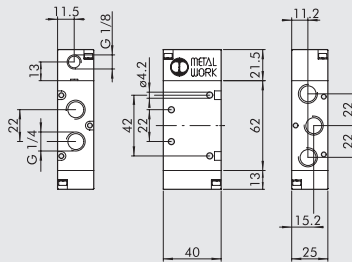

**MONOSTABLE 5/2, 1/4"**

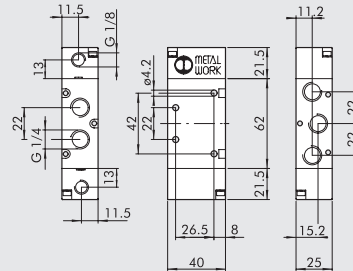

Symbol	Code	Abbrev.	Weight [g]
	7020011100	PNV 35 PNS OO	174

**BISTABLE 5/2, 1/4"**



Symbol	Code	Abbrev.	Weight [g]
	7020011200	PNV 35 PNB OO	174
	7020011300	PNV 35 PND OO	198

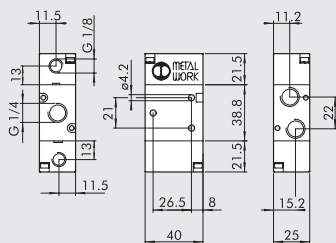

**BISTABLE 3/2, 1/4"**

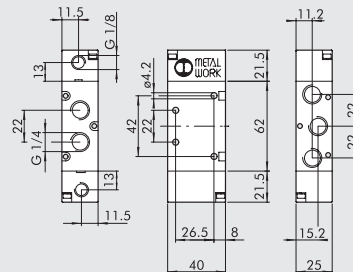

Symbol	Code	Abbrev.	Weight [g]
	7020010100	PNV 33 PNB OO	134

**DOUBLE 3/2, 1/4"**



Symbol	Code	Abbrev.	Weight [g]
	7020013100	PNV 38 PNS NC	223
	7020013200	PNV 38 PNS NO	223
	7020013300	PNV 38 PNS NC-NO	223

VALVES

VALVES SERIES 70, PNEUMATIC

MONOSTABLE 5/3, 1/4"

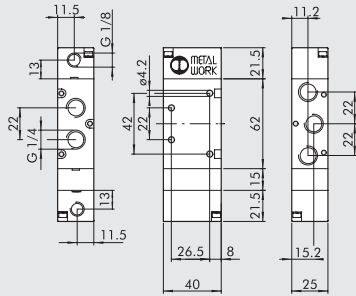

Symbol	Code	Abbrev.	Weight [g]
	7020012100	PNV 36 PNS CC	124
	7020012200	PNV 36 PNS OC	124
	7020012300	PNV 36 PNS PC	124

NOTES

VALVES SERIES 70, PNEUMATIC, 3/8"

MONOSTABLE 3/2 NO, 3/8"

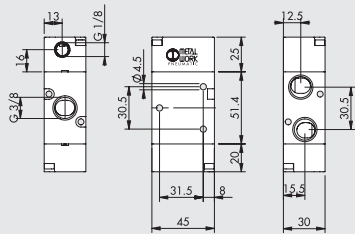

Symbol	Code	Abbrev.	Weight [g]
	7040010400	PNV C3 PNS NO	223

MONOSTABLE 3/2 NC, 3/8"

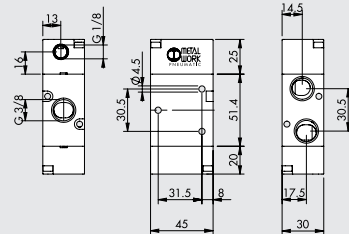

Symbol	Code	Abbrev.	Weight [g]
	7040010200	PNV C3 PNS NC	223

MONOSTABLE 5/2, 3/8"

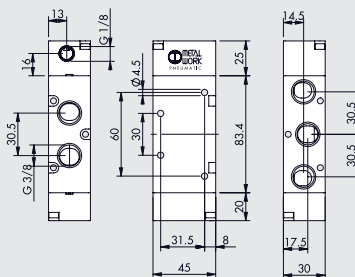

Symbol	Code	Abbrev.	Weight [g]
	7040011100	PNV C5 PNS OO	329

BISTABLE 5/2, 3/8"

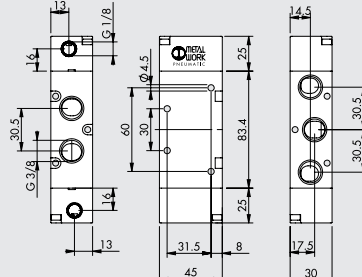

Symbol	Code	Abbrev.	Weight [g]
	7040011200	PNV C5 PNB OO	324
	7040011300	PNV C5 PND OO	360



**BISTABLE 3/2, 3/8"**

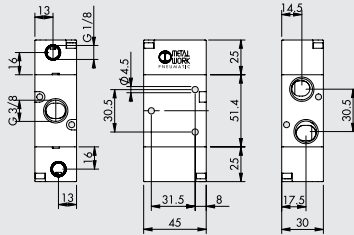

Symbol	Code	Abbrev.	Weight [g]
	7040010100	PNV C3 PNB OO	230

**MONOSTABLE 5/3, 3/8"**

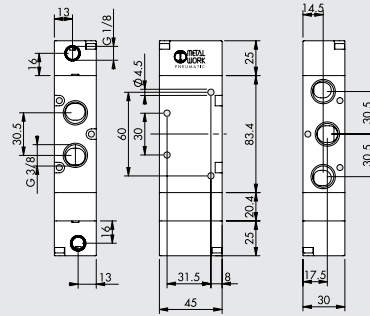

Symbol	Code	Abbrev.	Weight [g]
	7040012100	PNV C6 PNS CC	411
	7040012200	PNV C6 PNS OC	409
	7040012300	PNV C6 PNS PC	409

**VALVES SERIES 70, PNEUMATIC, 1/2"**

**MONOSTABLE 3/2 NO, 1/2"**

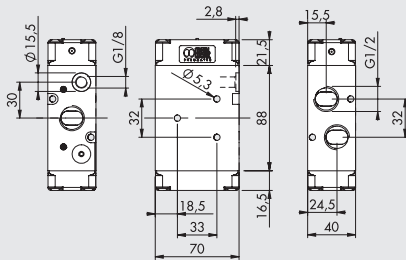

Symbol	Code	Abbrev.	Weight [g]
	7030010400	PNV 43 PNS NO	640

**MONOSTABLE 3/2 NC, 1/2"**

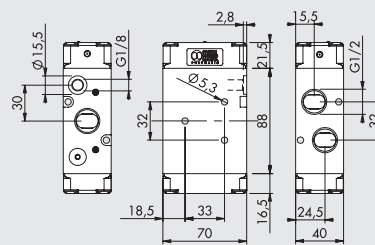

Symbol	Code	Abbrev.	Weight [g]
	7030010200	PNV 43 PNS NC	640

**MONOSTABLE 5/2, 1/2"**

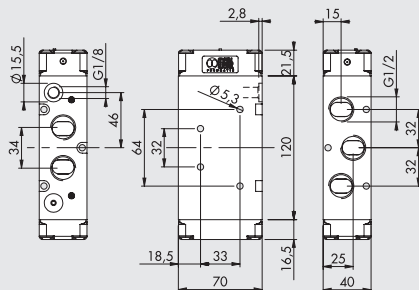

Symbol	Code	Abbrev.	Weight [g]
	7030011100	PNV 45 PNS OO	812

**BISTABLE 5/2, 1/2"**

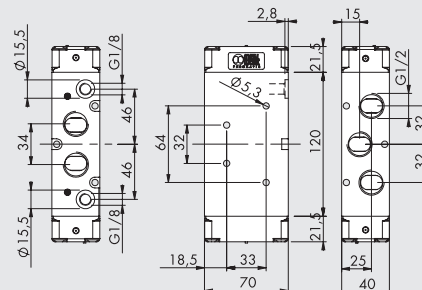



Symbol	Code	Abbrev.	Weight [g]
	7030011200	PNV 45 PNB OO	816
	7030011300	PNV 45 PND OO	828

VALVES

VALVES SERIES 70, PNEUMATIC

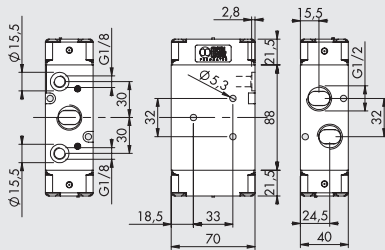

**BISTABLE 3/2, 1/2"**

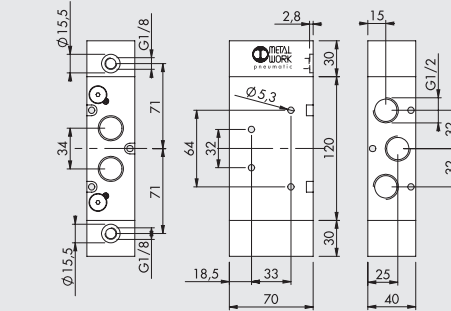

Symbol	Code	Abbrev.	Weight [g]
	7030010100	PNV 43 PNB OO	650

**MONOSTABLE 5/3, 1/2"**



Symbol	Code	Abbrev.	Weight [g]
	7030012100	PNV 46 PNS CC	1200
	7030012200	PNV 46 PNS OC	1194
	7030012300	PNV 46 PNS PC	1196

**NOTES**