

5/3-Wegeventil

pneumatisch

PLUS

Artikel Nr. 106518

Typen Nr. 516.602

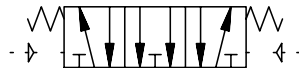

Beispielhafte Darstellung

Traditionelle Wegeventile der Reihe 70 in pneumatischer Ausführung. Diese Ventile finden einen breiten Anwendungsbereich als Muffenventil, Direktanbau am Zylinder mit Spezialadapter oder als Serienventile mit Mehrfach-Grundplatten und Einzelverkettungsplatten (Versorgungsleisten).

Technische Informationen

| | |
|-------------------------|--|
| Betriebsdruck | Vakuum bis 10 bar |
| Temperaturbereich | -10 bis 60 °C |
| Steuerdruck | 2,5 - 10 bar |
| Medium | Gefilterte Druckluft mit oder ohne Ölung. Wenn geölt, dann kontinuierlich. |
| Dichtmaterial | NBR |
| Durchflusswertmessung 1 | Durchfluss bei 6 bar und Δp 0,5 bar |
| Durchfluss 1 | 3200 NI/min |
| Durchflusswertmessung 2 | Durchfluss bei 6 bar und Δp 1,0 bar |
| Durchfluss 2 | 4600 NI/min |
| Anschluss | G 1/2 |
| DN | 15 |
| Funktion | 5/3 |
| Betätigung | Mitte entlüftet |
| Symbol | 30 |
| Serie | Ventile Reihe 70 |

Kaufmännische Daten

| | |
|-------------------------|------------------|
| Zolltarifnummer | 84818079 |
| Ursprungsland | IT |
| eCl@ss 5.1.4 | 27291501 |
| eCl@ss 9.0 | 27291390 |
| UNSPSC_Code_v190501 | 40141603 |
| UNSPSC_CodeDesc_v190501 | Pneumatic valves |

VENTILE REIHE 70

The Series 70 forms part of Metal Work's full range of traditional valves.

They are available in sizes 1/8", 1/4", 3/8" and 1/2", versions 3/2, 5/2, 5/3 and double 3/2, with mechanical, manual, pneumatic and electric drives.

They can be installed in line, onto a wall, on the cylinder (using a special bracket) or in series (on a multiple or modular base) to suit all possible applications.

A range of valves (Series 70 LT) designed using components for specific low-temperature applications is now available for the most commonly used types and sizes.

These highly reliable valves comply with the main applicable standards, including Atex, ISO 13489 and SIL, as stated in the documents and certificates available online.

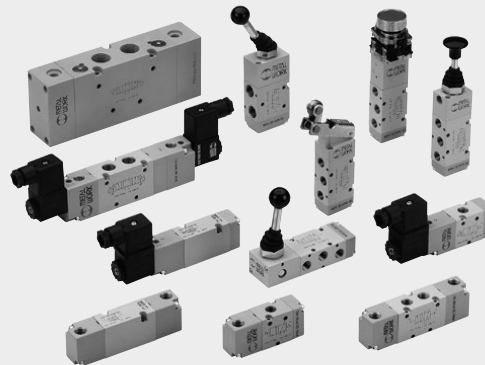

VENTILE

VENTILE REIHE 70

| TECHNISCHE DATEN | | 1/8" | 1/4" | 3/8" | 1/2" |
|--|-------------------|---|--------|-------------|--------|
| Anschluss | | 1/8" | 1/4" | 3/8" | 1/2" |
| Arbeitsdruckbereich series 70 versions | bar | | | 2.5 ÷ 10 | |
| monostabil | | | | 1 ÷ 10 | |
| bistabil | | | | Vakuum ÷ 10 | |
| mit externer Zuluft | | | | | |
| Operating pressure series 70 LT (low temperature) versions | bar | | | | |
| hand operated | | Vakuum ÷ 10 | | - | |
| pneumatic and solenoid/pneumatic | t = -40°C ÷ -10°C | 5 ÷ 10 | | - | |
| | t = -10°C ÷ +60°C | 3 ÷ 10 | | - | |
| Minimaler Druck der externen Zuluft | bar | | | 2.5 | |
| Temperaturbereich | °C | | | | |
| series 70 versions | | | | -10 ÷ +60 | |
| series 70 LT (low temperature) versions | | | | -40 ÷ +60 | |
| Nenn Durchmesser | mm | 5 | 7.5 | 13.3 | 15 |
| Durchflussleistung C | Nl/min · bar | 121.43 | 264.26 | 505.52 | 971.43 |
| Kritischer Faktor b | bar/bar | 0.32 | 0.27 | 0.32 | 0.43 |
| Durchfluss bei 6 bar ΔP 0.5 bar | Nl/min | 400 | 750 | 1560 | 3200 |
| Durchfluss bei 6 bar ΔP 1 bar | Nl/min | 550 | 1100 | 2150 | 4600 |
| Einbaulage | | In jeder Positionen (nicht für bistabile Ventile bei Vibrationen). | | | |
| Medium | | Gefilterte Druckluft mit oder ohne Ölung. Wenn geölt, dann kontinuierlich. | | | |
| Empfohlene Öle | | For series 70 LT (low-temperature) versions, it is recommended to use of perferamente dried air. ISO und UNI FD 22 | | | |
| Maximales Drehmoment für die Spulennutter | Nm | For series 70 LT (low-temperature) it is not expected to be used with lubricated air. | | | |
| Kompatibilität mit Ölen | | 1 Siehe Kapitel Z1 | | | |

KOMPONENTEN

- ① VENTILKÖRPER: Aluminium oberflächenvergütet
- ② ENDSTÜCKE: Kunststoff
- ③ KOLBEN: chemisch vernickeltes Aluminium
- ④ DISTANZSTÜCK: Kunststoff
- ⑤ DICHTUNGEN: NBR
- ⑥ HILFSKOLBEN: Hostaform®
- ⑦ HILFSKOLBEN-DICHTUNG: NBR
- ⑧ FILTER: gesinterte Bronze
- ⑨ FEDER: Sonderstahl
- ⑩ ANKERSYSTEM: Messinghülse mit Edelstahl-Kern

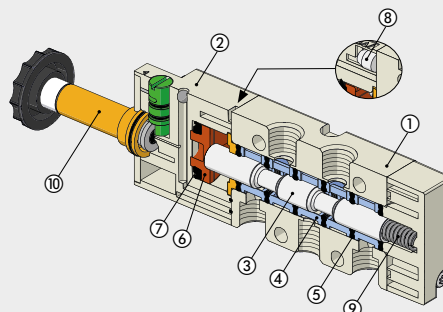

COMPONENTS SERIES 70 LT (LOW TEMPERATURE)

- ① VENTILKÖRPER: Aluminium oberflächenvergütet
- ② ENDSTÜCKE: Aluminium
- ③ KOLBEN: chemisch vernickeltes Aluminium
- ④ DISTANZSTÜCK: Kunststoff
- ⑤ DICHTUNGEN: NBR
- ⑥ HILFSKOLBEN: Aluminium
- ⑦ HILFSKOLBEN-DICHTUNG: NBR
- ⑧ FILTER: gesinterte Bronze
- ⑨ FEDER: Sonderstahl
- ⑩ ANKERSYSTEM: Messinghülse mit Edelstahl-Kern
(version specific for low-temperature applications)

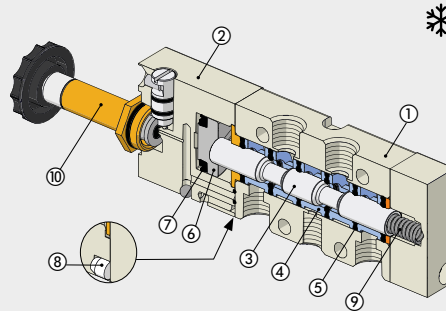

VENTILE

DURCHFLUSSDIAGRAMM

VENTILE REIHE 70 1/8"

Durchfluss

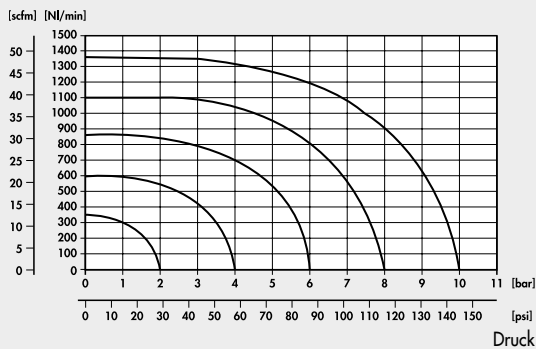

VENTILE REIHE 70 1/4"

Durchfluss

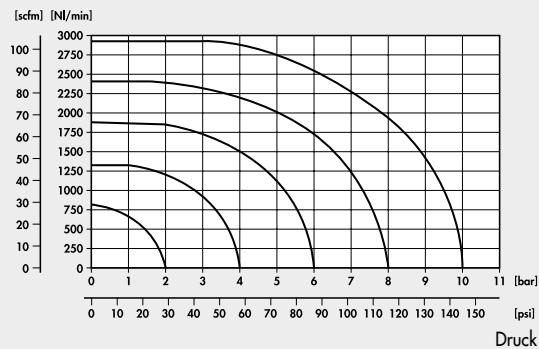

VENTILE REIHE 70

VENTILE REIHE 70 3/8"

Durchfluss

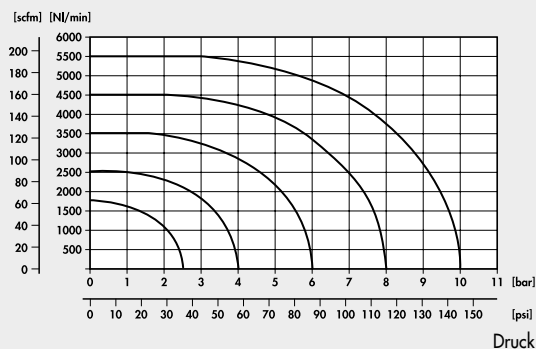

VENTILE REIHE 70 1/2"

Durchfluss

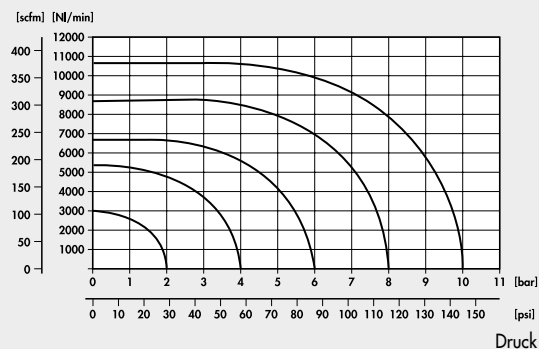

VENTILE REIHE 70, PNEUMATISCH

| TECHNISCHE DATEN | | 1/8" | 1/4" | 3/8" | 1/2" |
|---------------------------------|--------------|-------------|--------|--------|--------|
| Arbeitsdruckbereich | bar | Vakuum ÷ 10 | | | |
| Minimaler Arbeitsdruck | | | | | |
| • monostabil | bar | 2.5 | | | |
| • bistabil | bar | 1 | | | |
| Temperaturbereich | °C | -10 ÷ +60 | | | |
| Nenn Durchmesser | mm | 5 | 7.5 | 13.3 | 15 |
| Durchflussleistung C | Nl/min · bar | 121.43 | 264.26 | 505.52 | 971.43 |
| Kritischer Faktor b | bar/bar | 0.32 | 0.27 | 0.32 | 0.43 |
| Durchfluss bei 6 bar ΔP 0.5 bar | Nl/min | 400 | 750 | 1560 | 3200 |
| Durchfluss bei 6 bar ΔP 1 bar | Nl/min | 550 | 1100 | 2150 | 4600 |
| TRA / TRR monostabil bei 6 bar | ms | 6/15 | 7/15 | 5/28 | 16/80 |
| TRA / TRR monostabil bei 6 bar | ms | 7/7 | 7/7 | 13/13 | 25/25 |
| Handhilfsbetätigung | | - | - | - | * |



* Monostabil am Ventilkörper

VENTILE

TYPENSCHLÜSSEL

| PNV FAMILIE | 2 ANSCHLÜSSE | 3 FUNKTION | PN BETÄTIGUNG 14 | S RÜCKSTELLUNG (12) | NC WEITERE MERKMALE |
|--------------------------|--------------------------------------|--------------------------------------|------------------|--|--|
| PNV Pneumatische Ventile | 2 1/8" 3 1/4" C 3/8" 4 1/2" | 3 3/2 5 5/2 6 5/3 ■ 8 2-3/2 | PN Pneumatisch | S Mechanische Feder B Bistabil D Differentialkolben O Mittelstellung 5/3 ◆ A Pneumatisch/mechanische Feder | OO no indication NC Normal geschlossen NO Normal offen CC Zentrum geschlossen OC Zentrum entlüftet PC Zentrum belüftet ▲ NC-NO Normal geschlossen - Normal offen |

- Nur verfügbar für Anschlussgröße 1/8" und 1/4"
- ◆ Auf Anforderung
- ▲ Nur verfügbar für die 2 x 3/2 Wege Funktion

VENTILE REIHE 70, PNEUMATISCH

VENTILE REIHE 70, PNEUMATISCH, 1/8"

MONOSTABIL 3/2 NO, 1/8"

MONOSTABIL 3/2 NC, 1/8"

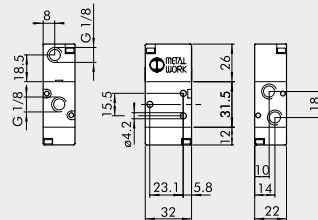
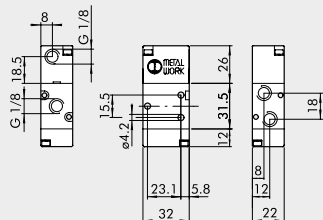

| Symbol | Bestellnummer | Typ | Gewicht [g] |
|--------|---------------|---------------|-------------|
| | 7010010400 | PNV 23 PNS NO | 82 |

| Symbol | Bestellnummer | Typ | Gewicht [g] |
|--------|---------------|---------------|-------------|
| | 7010010200 | PNV 23 PNS NC | 82 |

B1

VENTILE

VENTILE REIHE 70, PNEUMATISCH

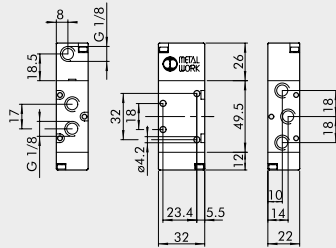

MONOSTABIL 5/2, 1/8"

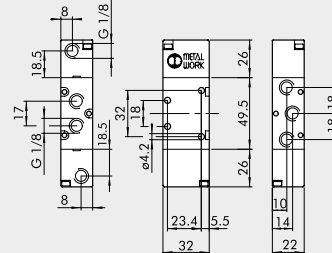

| Symbol | Bestellnummer | Typ | Gewicht [g] |
|---|---------------|---------------|-------------|
|  | 7010011100 | PNV 25 PNS OO | 108 |

BISTABIL 5/2, 1/8"



| Symbol | Bestellnummer | Typ | Gewicht [g] |
|---|---------------|---------------|-------------|
|  | 7010011200 | PNV 25 PNB OO | 122 |
|  | 7010011300 | PNV 25 PND OO | 128 |

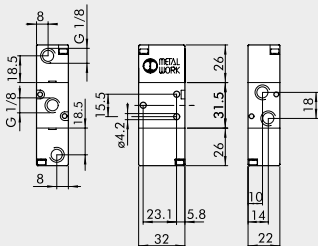

BISTABIL 3/2, 1/8"



| Symbol | Bestellnummer | Typ | Gewicht [g] |
|---|---------------|---------------|-------------|
|  | 7010010100 | PNV 23 PNB OO | 96 |

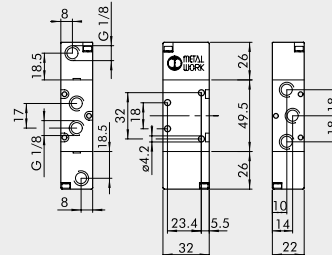

DOPPELT 3/2, 1/8"

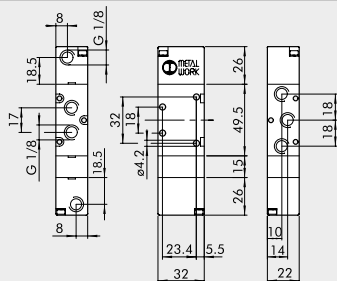

| Symbol | Bestellnummer | Typ | Gewicht [g] |
|---|---------------|------------------|-------------|
|  | 7010013100 | PNV 28 PNS NC | 136 |
|  | 7010013200 | PNV 28 PNS NO | 136 |
|  | 7010013300 | PNV 28 PNS NC-NO | 136 |

MITTELSTELLUNGS-VENTIL 5/3, 1/8"



| Symbol | Bestellnummer | Typ | Gewicht [g] |
|---|---------------|---------------|-------------|
|  | 7010012100 | PNV 26 PNS CC | 150 |
|  | 7010012200 | PNV 26 PNS OC | 150 |
|  | 7010012300 | PNV 26 PNS PC | 150 |

ANMERKUNGEN

B1.24

VENTILE REIHE 70, PNEUMATISCH, 1/4"

MONOSTABIL 3/2 NO, 1/4"

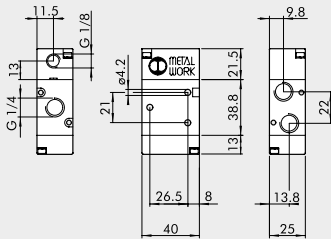

| Symbol | Bestellnummer | Typ | Gewicht [g] |
|--------|---------------|---------------|-------------|
| | 7020010400 | PNV 33 PNS NO | 124 |

MONOSTABIL 3/2 NC, 1/4"

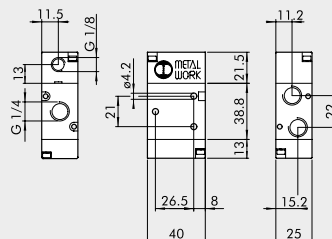

| Symbol | Bestellnummer | Typ | Gewicht [g] |
|--------|---------------|---------------|-------------|
| | 7020010200 | PNV 33 PNS NC | 122 |

MONOSTABIL 5/2, 1/4"

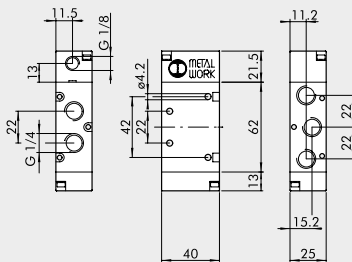

| Symbol | Bestellnummer | Typ | Gewicht [g] |
|--------|---------------|---------------|-------------|
| | 7020011100 | PNV 35 PNS OO | 174 |

BISTABIL 5/2, 1/4"

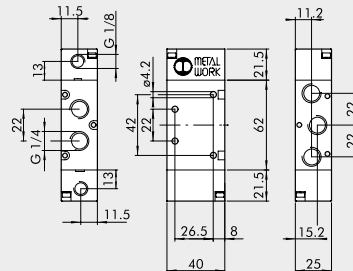

| Symbol | Bestellnummer | Typ | Gewicht [g] |
|--------|---------------|---------------|-------------|
| | 7020011200 | PNV 35 PNB OO | 174 |
| | 7020011300 | PNV 35 PND OO | 198 |

BISTABIL 3/2, 1/4"

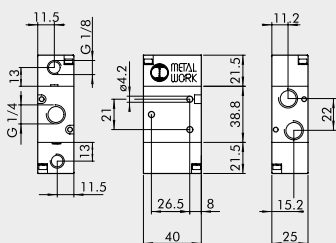

| Symbol | Bestellnummer | Typ | Gewicht [g] |
|--------|---------------|---------------|-------------|
| | 7020010100 | PNV 33 PNB OO | 134 |

DOPPELT 3/2, 1/4"

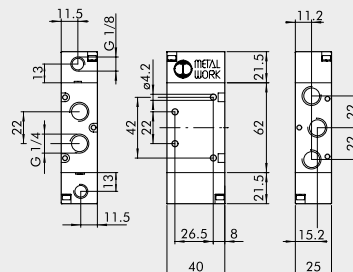

| Symbol | Bestellnummer | Typ | Gewicht [g] |
|--------|---------------|------------------|-------------|
| | 7020013100 | PNV 38 PNS NC | 223 |
| | 7020013200 | PNV 38 PNS NO | 223 |
| | 7020013300 | PNV 38 PNS NC-NO | 223 |

VENTILE

VENTILE REIHE 70, PNEUMATISCH

MITTELSTELLUNGS-VENTIL 5/3, 1/4"

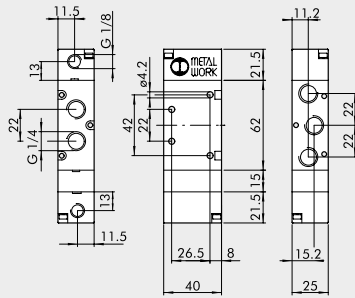

| Symbol | Bestellnummer | Typ | Gewicht [g] |
|--------|---------------|---------------|-------------|
| | 7020012100 | PNV 36 PNS CC | 124 |
| | 7020012200 | PNV 36 PNS OC | 124 |
| | 7020012300 | PNV 36 PNS PC | 124 |

ANMERKUNGEN

VENTILE REIHE 70, PNEUMATISCH, 3/8"

MONOSTABIL 3/2 NO, 3/8"

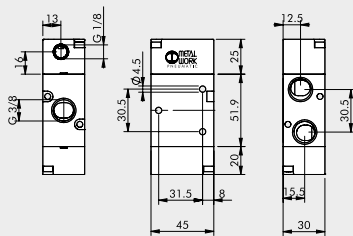

| Symbol | Bestellnummer | Typ | Gewicht [g] |
|--------|---------------|---------------|-------------|
| | 7040010400 | PNV C3 PNS NO | 223 |

MONOSTABIL 3/2 NC, 3/8"

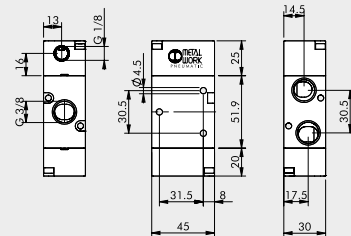

| Symbol | Bestellnummer | Typ | Gewicht [g] |
|--------|---------------|---------------|-------------|
| | 7040010200 | PNV C3 PNS NC | 223 |

MONOSTABIL 5/2, 3/8"

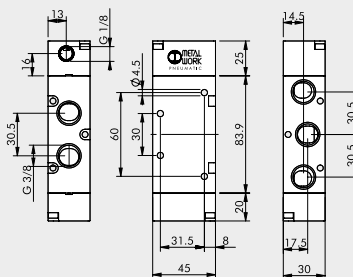

| Symbol | Bestellnummer | Typ | Gewicht [g] |
|--------|---------------|---------------|-------------|
| | 7040011100 | PNV C5 PNS OO | 329 |

BISTABIL 5/2, 3/8"

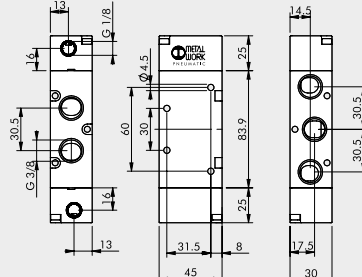

| Symbol | Bestellnummer | Typ | Gewicht [g] |
|--------|---------------|---------------|-------------|
| | 7040011200 | PNV C5 PNB OO | 324 |
| | 7040011300 | PNV C5 PND OO | 360 |

BISTABIL 3/2, 3/8"

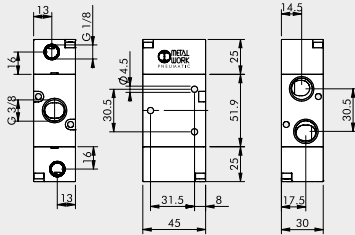

| Symbol | Bestellnummer | Typ | Gewicht [g] |
|--------|---------------|---------------|-------------|
| | 7040010100 | PNV C3 PNB OO | 230 |

MONOSTABIL 5/3, 3/8"

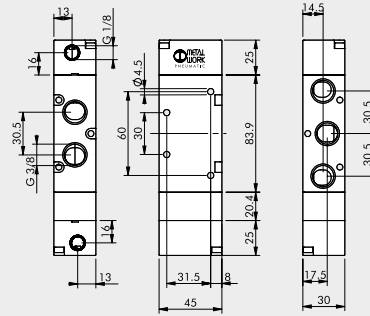

| Symbol | Bestellnummer | Typ | Gewicht [g] |
|--------|---------------|---------------|-------------|
| | 7040012100 | PNV C6 PNS CC | 411 |
| | 7040012200 | PNV C6 PNS OC | 409 |
| | 7040012300 | PNV C6 PNS PC | 409 |

VENTILE REIHE 70, PNEUMATISCH, 1/2"

MONOSTABIL 3/2 NO, 1/2"

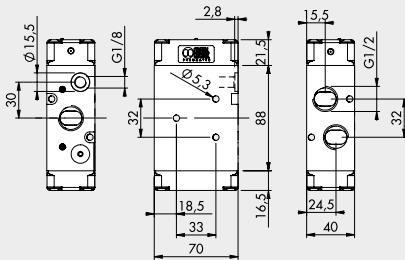

| Symbol | Bestellnummer | Typ | Gewicht [g] |
|--------|---------------|---------------|-------------|
| | 7030010400 | PNV 43 PNS NO | 640 |

MONOSTABIL 3/2 NC, 1/2"

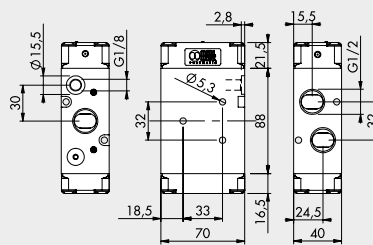

| Symbol | Bestellnummer | Typ | Gewicht [g] |
|--------|---------------|---------------|-------------|
| | 7030010200 | PNV 43 PNS NC | 640 |

MONOSTABIL 5/2, 1/2"

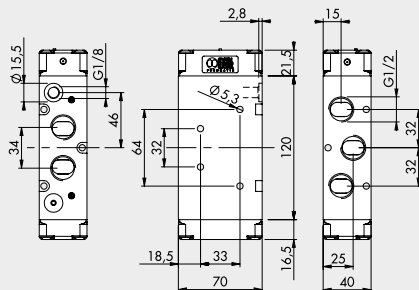

| Symbol | Bestellnummer | Typ | Gewicht [g] |
|--------|---------------|---------------|-------------|
| | 7030011100 | PNV 45 PNS OO | 812 |

BISTABIL 5/2, 1/2"

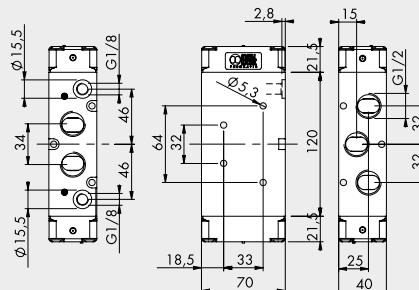



| Symbol | Bestellnummer | Typ | Gewicht [g] |
|--------|---------------|---------------|-------------|
| | 7030011200 | PNV 45 PNB OO | 816 |
| | 7030011300 | PNV 45 PND OO | 828 |

VENTILE

VENTILE REIHE 70, PNEUMATISCH

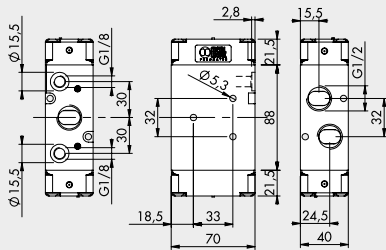
BISTABIL 3/2, 1/2"



| Symbol | Bestellnummer | Typ | Gewicht [g] |
|---|---------------|---------------|-------------|
|  | 7030010100 | PNV 43 PNB OO | 650 |

MITTELSTELLUNGS-VENTIL 5/3, 1/2"

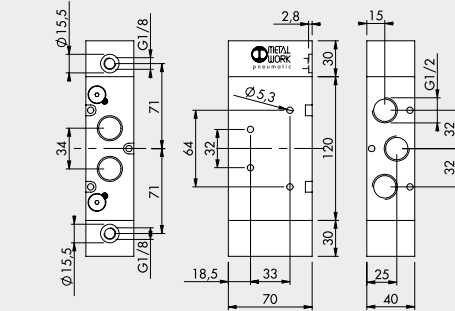

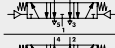
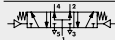
| Symbol | Bestellnummer | Typ | Gewicht [g] |
|--|---------------|---------------|-------------|
|  | 7030012100 | PNV 46 PNS CC | 1200 |
|  | 7030012200 | PNV 46 PNS OC | 1194 |
|  | 7030012300 | PNV 46 PNS PC | 1196 |

ANMERKUNGEN