

5/2-Wegeventil

pneumatisch

PLUS

Artikel Nr. 106507

Typen Nr. 516.306

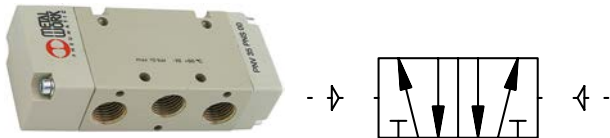

Beispielhafte Darstellung

Traditionelle Wegeventile der Reihe 70 in pneumatischer Ausführung. Diese Ventile finden einen breiten Anwendungsbereich als Muffenventil, Direktanbau am Zylinder mit Spezialadapter oder als Serienventile mit Mehrfach-Grundplatten und Einzelverkettungsplatten (Versorgungsleisten).

Technische Informationen

Betriebsdruck	Vakuum bis 10 bar
Temperaturbereich	-10 bis 60 °C
Steuerdruck	1 - 10 bar
Medium	Gefilterte Druckluft mit oder ohne Ölung. Wenn geölt, dann kontinuierlich.
Dichtmaterial	NBR
Durchflusswertmessung 1	Durchfluss bei 6 bar und Δp 0,5 bar
Durchfluss 1	3200 NI/min
Durchflusswertmessung 2	Durchfluss bei 6 bar und Δp 1,0 bar
Durchfluss 2	4600 NI/min
Anschluss	G 1/2
DN	15
Funktion	5/2
Betätigung	bistabil
Symbol	28
Serie	Ventile Reihe 70

Kaufmännische Daten

Zolltarifnummer	84818079
Ursprungsland	IT
eCl@ss 5.1.4	27291501
eCl@ss 9.0	27291390
UNSPSC_Code_v190501	40141603
UNSPSC_CodeDesc_v190501	Pneumatic valves

VENTILE REIHE 70

The Series 70 forms part of Metal Work's full range of traditional valves.

They are available in sizes 1/8", 1/4", 3/8" and 1/2", versions 3/2, 5/2, 5/3 and double 3/2, with mechanical, manual, pneumatic and electric drives.

They can be installed in line, onto a wall, on the cylinder (using a special bracket) or in series (on a multiple or modular base) to suit all possible applications.

A range of valves (Series 70 LT) designed using components for specific low-temperature applications is now available for the most commonly used types and sizes.

These highly reliable valves comply with the main applicable standards, including Atex, ISO 13489 and SIL, as stated in the documents and certificates available online.



VENTILE

VENTILE REIHE 70

TECHNISCHE DATEN		1/8"	1/4"	3/8"	1/2"
Anschluss		1/8"	1/4"	3/8"	1/2"
Arbeitsdruckbereich series 70 versions	bar			2.5 ÷ 10	
monostabil				1 ÷ 10	
bistabil				Vakuum ÷ 10	
mit externer Zuluft					
Operating pressure series 70 LT (low temperature) versions	bar				
hand operated		Vakuum ÷ 10		-	
pneumatic and solenoid/pneumatic	t = -40°C ÷ -10°C	5 ÷ 10		-	
	t = -10°C ÷ +60°C	3 ÷ 10		-	
Minimaler Druck der externen Zuluft	bar			2.5	
Temperaturbereich	°C				
series 70 versions				-10 ÷ +60	
series 70 LT (low temperature) versions				-40 ÷ +60	
Nenn Durchmesser	mm	5	7.5	13.3	15
Durchflussleistung C	Nl/min · bar	121.43	264.26	505.52	971.43
Kritischer Faktor b	bar/bar	0.32	0.27	0.32	0.43
Durchfluss bei 6 bar ΔP 0.5 bar	Nl/min	400	750	1560	3200
Durchfluss bei 6 bar ΔP 1 bar	Nl/min	550	1100	2150	4600
Einbaulage		In jeder Positionen (nicht für bistabile Ventile bei Vibrationen).			
Medium		Gefilterte Druckluft mit oder ohne Ölung. Wenn geölt, dann kontinuierlich.			
Empfohlene Öle		For series 70 LT (low-temperature) versions, it is recommended to use of perferamente dried air. ISO und UNI FD 22			
Maximales Drehmoment für die Spulennutter	Nm	For series 70 LT (low-temperature) it is not expected to be used with lubricated air.			
Kompatibilität mit Ölen		1 Siehe Kapitel Z1			

KOMPONENTEN

- ① VENTILKÖRPER: Aluminium oberflächenvergütet
- ② ENDSTÜCKE: Kunststoff
- ③ KOLBEN: chemisch vernickeltes Aluminium
- ④ DISTANZSTÜCK: Kunststoff
- ⑤ DICHTUNGEN: NBR
- ⑥ HILFSKOLBEN: Hostaform®
- ⑦ HILFSKOLBEN-DICHTUNG: NBR
- ⑧ FILTER: gesinterte Bronze
- ⑨ FEDER: Sonderstahl
- ⑩ ANKERSYSTEM: Messinghülse mit Edelstahl-Kern

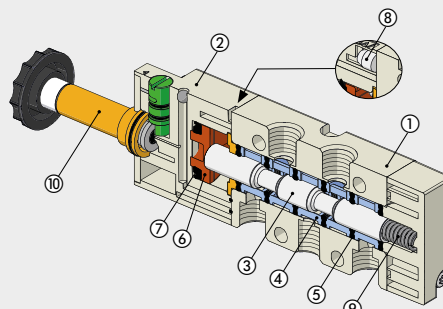

COMPONENTS SERIES 70 LT (LOW TEMPERATURE)

- ① VENTILKÖRPER: Aluminium oberflächenvergütet
- ② ENDSTÜCKE: Aluminium
- ③ KOLBEN: chemisch vernickeltes Aluminium
- ④ DISTANZSTÜCK: Kunststoff
- ⑤ DICHTUNGEN: NBR
- ⑥ HILFSKOLBEN: Aluminium
- ⑦ HILFSKOLBEN-DICHTUNG: NBR
- ⑧ FILTER: gesinterte Bronze
- ⑨ FEDER: Sonderstahl
- ⑩ ANKERSYSTEM: Messinghülse mit Edelstahl-Kern
(version specific for low-temperature applications)



VENTILE

DURCHFLUSSDIAGRAMM

VENTILE REIHE 70 1/8"

Durchfluss

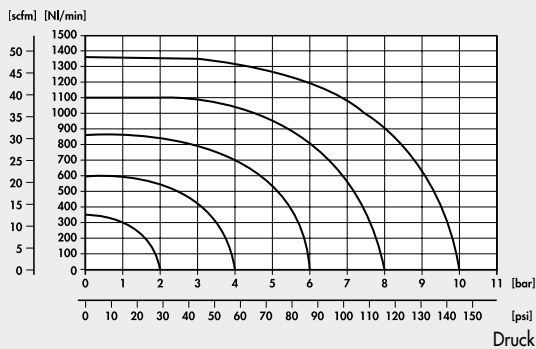

VENTILE REIHE 70 1/4"

Durchfluss



VENTILE REIHE 70

VENTILE REIHE 70 3/8"

Durchfluss



VENTILE REIHE 70 1/2"

Durchfluss



VENTILE REIHE 70, PNEUMATISCH

TECHNISCHE DATEN		1/8"	1/4"	3/8"	1/2"
Arbeitsdruckbereich	bar	Vakuum ÷ 10			
Minimaler Arbeitsdruck					
• monostabil	bar	2.5			
• bistabil	bar	1			
Temperaturbereich	°C	-10 ÷ +60			
Nenn Durchmesser	mm	5	7.5	13.3	15
Durchflussleistung C	Nl/min · bar	121.43	264.26	505.52	971.43
Kritischer Faktor b	bar/bar	0.32	0.27	0.32	0.43
Durchfluss bei 6 bar ΔP 0.5 bar	Nl/min	400	750	1560	3200
Durchfluss bei 6 bar ΔP 1 bar	Nl/min	550	1100	2150	4600
TRA / TRR monostabil bei 6 bar	ms	6/15	7/15	5/28	16/80
TRA / TRR monostabil bei 6 bar	ms	7/7	7/7	13/13	25/25
Handhilfsbetätigung		-	-	-	*



* Monostabil am Ventilkörper

VENTILE

TYPENSCHLÜSSEL

PNV FAMILIE	2 ANSCHLÜSSE	3 FUNKTION	PN BETÄTIGUNG 14	S RÜCKSTELLUNG (12)	NC WEITERE MERKMALE
PNV Pneumatische Ventile	2 1/8" 3 1/4" C 3/8" 4 1/2"	3 3/2 5 5/2 6 5/3 ■ 8 2-3/2	PN Pneumatisch	S Mechanische Feder B Bistabil D Differentialkolben O Mittelstellung 5/3 ◆ A Pneumatisch/mechanische Feder	OO no indication NC Normal geschlossen NO Normal offen CC Zentrum geschlossen OC Zentrum entlüftet PC Zentrum belüftet ▲ NC-NO Normal geschlossen - Normal offen

- Nur verfügbar für Anschlussgröße 1/8" und 1/4"
- ◆ Auf Anforderung
- ▲ Nur verfügbar für die 2 x 3/2 Wege Funktion

VENTILE REIHE 70, PNEUMATISCH

VENTILE REIHE 70, PNEUMATISCH, 1/8"

MONOSTABIL 3/2 NO, 1/8"

MONOSTABIL 3/2 NC, 1/8"

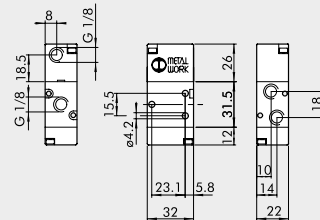
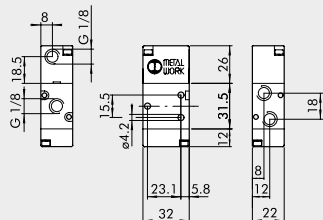

Symbol	Bestellnummer	Typ	Gewicht [g]
	7010010400	PNV 23 PNS NO	82

Symbol	Bestellnummer	Typ	Gewicht [g]
	7010010200	PNV 23 PNS NC	82

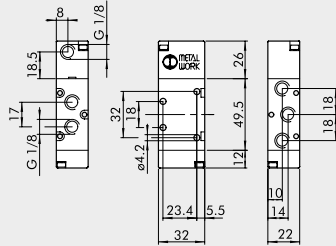
MONOSTABIL 5/2, 1/8"

Symbol	Bestellnummer	Typ	Gewicht [g]
	7010011100	PNV 25 PNS OO	108

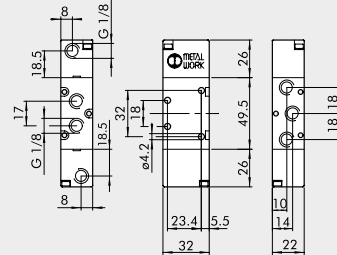
BISTABIL 5/2, 1/8"

Symbol	Bestellnummer	Typ	Gewicht [g]
	7010011200	PNV 25 PNB OO	122
	7010011300	PNV 25 PND OO	128

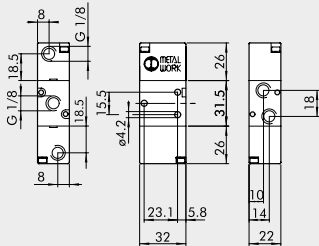
BISTABIL 3/2, 1/8"

Symbol	Bestellnummer	Typ	Gewicht [g]
	7010010100	PNV 23 PNB OO	96

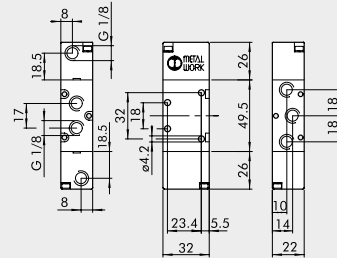
DOPPELT 3/2, 1/8"

Symbol	Bestellnummer	Typ	Gewicht [g]
	7010013100	PNV 28 PNS NC	136
	7010013200	PNV 28 PNS NO	136
	7010013300	PNV 28 PNS NC-NO	136

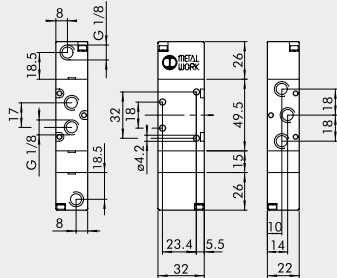
MITTELSTELLUNGS-VENTIL 5/3, 1/8"

Symbol	Bestellnummer	Typ	Gewicht [g]
	7010012100	PNV 26 PNS CC	150
	7010012200	PNV 26 PNS OC	150
	7010012300	PNV 26 PNS PC	150

ANMERKUNGEN

VENTILE REIHE 70, PNEUMATISCH, 1/4"

MONOSTABIL 3/2 NO, 1/4"

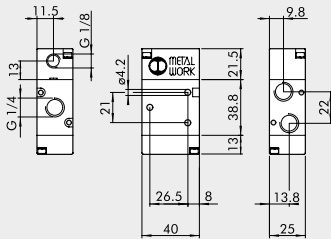

Symbol	Bestellnummer	Typ	Gewicht [g]
	7020010400	PNV 33 PNS NO	124

MONOSTABIL 3/2 NC, 1/4"

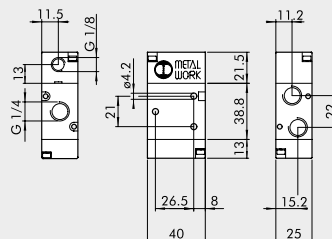

Symbol	Bestellnummer	Typ	Gewicht [g]
	7020010200	PNV 33 PNS NC	122

MONOSTABIL 5/2, 1/4"

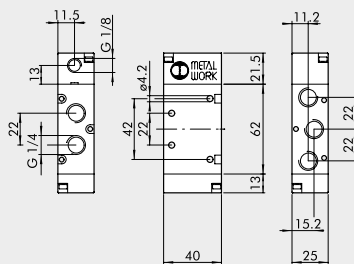

Symbol	Bestellnummer	Typ	Gewicht [g]
	7020011100	PNV 35 PNS OO	174

BISTABIL 5/2, 1/4"

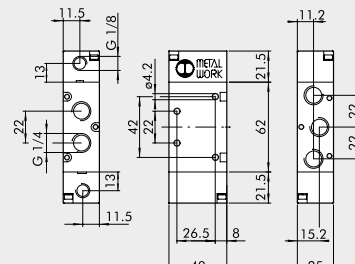

Symbol	Bestellnummer	Typ	Gewicht [g]
	7020011200	PNV 35 PNB OO	174
	7020011300	PNV 35 PND OO	198

BISTABIL 3/2, 1/4"

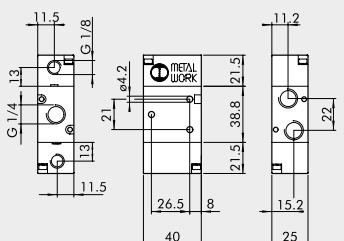

Symbol	Bestellnummer	Typ	Gewicht [g]
	7020010100	PNV 33 PNB OO	134

DOPPELT 3/2, 1/4"

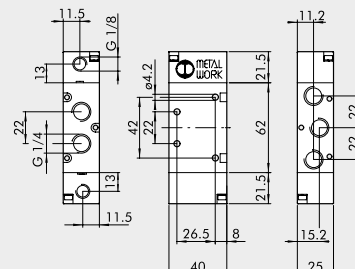

Symbol	Bestellnummer	Typ	Gewicht [g]
	7020013100	PNV 38 PNS NC	223
	7020013200	PNV 38 PNS NO	223
	7020013300	PNV 38 PNS NC-NO	223

VENTILE

VENTILE REIHE 70, PNEUMATISCH

MITTELSTELLUNGS-VENTIL 5/3, 1/4"

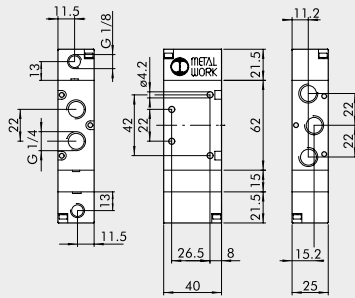

Symbol	Bestellnummer	Typ	Gewicht [g]
	7020012100	PNV 36 PNS CC	124
	7020012200	PNV 36 PNS OC	124
	7020012300	PNV 36 PNS PC	124

ANMERKUNGEN

VENTILE REIHE 70, PNEUMATISCH, 3/8"

MONOSTABIL 3/2 NO, 3/8"

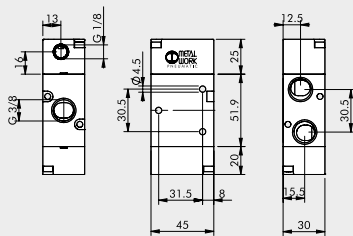

Symbol	Bestellnummer	Typ	Gewicht [g]
	7040010400	PNV C3 PNS NO	223

MONOSTABIL 3/2 NC, 3/8"

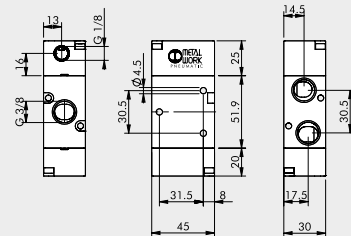

Symbol	Bestellnummer	Typ	Gewicht [g]
	7040010200	PNV C3 PNS NC	223

MONOSTABIL 5/2, 3/8"

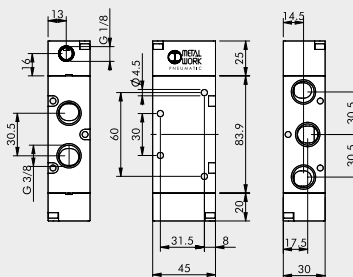

Symbol	Bestellnummer	Typ	Gewicht [g]
	7040011100	PNV C5 PNS OO	329

BISTABIL 5/2, 3/8"

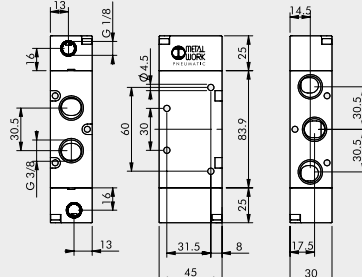

Symbol	Bestellnummer	Typ	Gewicht [g]
	7040011200	PNV C5 PNB OO	324
	7040011300	PNV C5 PND OO	360

BISTABIL 3/2, 3/8"

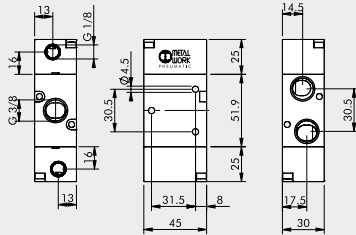

Symbol	Bestellnummer	Typ	Gewicht [g]
	7040010100	PNV C3 PNB OO	230

MONOSTABIL 5/3, 3/8"

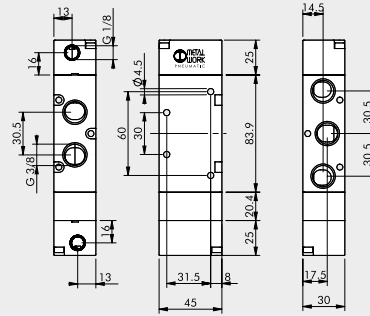

Symbol	Bestellnummer	Typ	Gewicht [g]
	7040012100	PNV C6 PNS CC	411
	7040012200	PNV C6 PNS OC	409
	7040012300	PNV C6 PNS PC	409

VENTILE REIHE 70, PNEUMATISCH, 1/2"

MONOSTABIL 3/2 NO, 1/2"

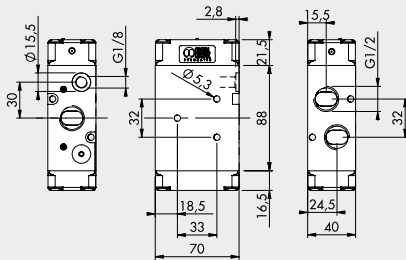

Symbol	Bestellnummer	Typ	Gewicht [g]
	7030010400	PNV 43 PNS NO	640

MONOSTABIL 3/2 NC, 1/2"



Symbol	Bestellnummer	Typ	Gewicht [g]
	7030010200	PNV 43 PNS NC	640

MONOSTABIL 5/2, 1/2"

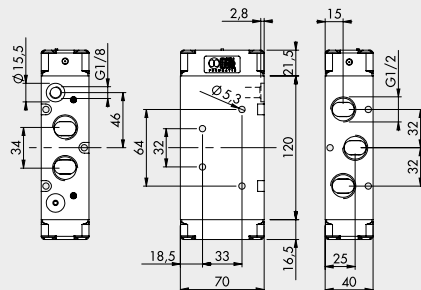

Symbol	Bestellnummer	Typ	Gewicht [g]
	7030011100	PNV 45 PNS OO	812

BISTABIL 5/2, 1/2"

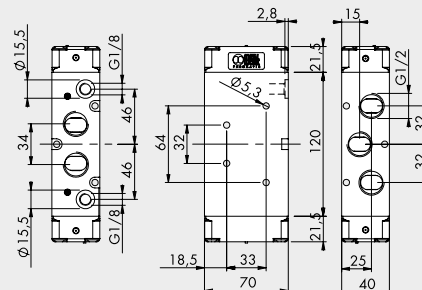

Symbol	Bestellnummer	Typ	Gewicht [g]
	7030011200	PNV 45 PNB OO	816
	7030011300	PNV 45 PND OO	828

VENTILE

VENTILE REIHE 70, PNEUMATISCH

B1

VENTILE

VENTILE REIHE 70, PNEUMATISCH

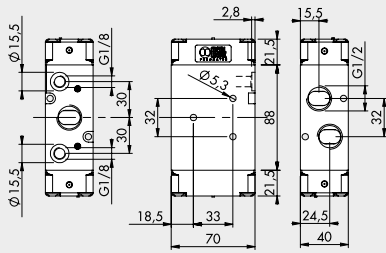

BISTABIL 3/2, 1/2"

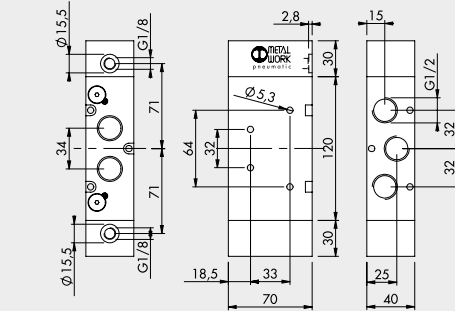

Symbol	Bestellnummer	Typ	Gewicht [g]
	7030010100	PNV 43 PNB OO	650

MITTELSTELLUNGS-VENTIL 5/3, 1/2"

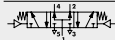

Symbol	Bestellnummer	Typ	Gewicht [g]
	7030012100	PNV 46 PNS CC	1200
	7030012200	PNV 46 PNS OC	1194
	7030012300	PNV 46 PNS PC	1196

ANMERKUNGEN

B1.28