

## 3/2-way valve

manually operated, for panel mounting

**PLUS** ||

Art. No. 106424

Type No. 515.502

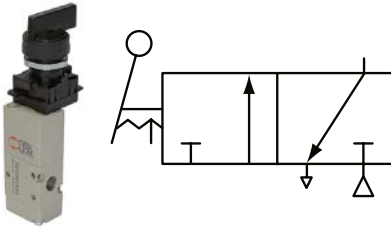

Exemplary illustration

Traditional way valves of series 70 in manually operated version for panel mounting.

### Technical data

Operating pressure	2.5 - 10 bar
Temperature range	-10 to 60 °C
Valve body	Aluminium
Piston	Aluminium
Medium	Filtered compressed air with or without lubrication. If lubricated, then continuous.
Sealant	NBR
Spring	Special steel
Flow rate measurement 1	Flow rate at 6 bar and $\Delta p$ 0.5 bar
Flow rate 1	400 NI/min
Flow rate measurement 2	Flow rate at 6 bar and $\Delta p$ 1.0 bar
Flow rate 2	550 NI/min
Connection	G 1/8
Function	3/2 NC
Operation	Bistable
Valve positions	2
Symbol	10
Series	Valves series 70
TechnischerHinweis1	3 valve positions only in conjunction with a second 3/2-way valve 515.101 type. Corresponds to a 5/3-way valve.

## Commercial data

Customs tariff number	84818099
Country of origin	IT
eCl@ss 5.1.4	27291801
eCl@ss 9.0	27291390
UNSPSC_Code_v190501	40141603
UNSPSC_CodeDesc_v190501	Pneumatic valves

## VALVES SERIES 70

The Series 70 forms part of Metal Work's full range of traditional valves.  
They are available in sizes 1/8", 1/4", 3/8" and 1/2", versions 3/2, 5/2, 5/3 and double 3/2, with mechanical, manual, pneumatic and electric drives.  
They can be installed in line, onto a wall, on the cylinder (using a special bracket) or in series (on a multiple or modular base) to suit all possible applications.

A range of valves (Series 70 LT) designed using components for specific low-temperature applications is now available for the most commonly used types and sizes.

These highly reliable valves comply with the main applicable standards, including Atex, ISO 13489 and SIL, as stated in the documents and certificates available online.



TECHNICAL DATA		1/8"	1/4"	3/8"	1/2"
Thread on the valve ports		1/8"	1/4"	3/8"	1/2"
Operating pressure series 70 versions	bar	2.5 to 10			
monostable and bistable differential		1 to 10			
bistable		vacuum to 10			
asserved					
Operating pressure series 70 LT (low temperature) versions	bar	vacuum to 10			
hand operated		vacuum to 10			-
pneumatic and solenoid/pneumatic	t = -40°C to -10°C	5 to 10			-
	t = -10°C to +60°C	3 to 10			-
Minimum pilot pressure	bar	2.5			
Operating temperature range	°C	-10 to +60			
series 70 versions		-40 to +60			
series 70 LT (low temperature) versions					
Nominal diameter	mm	5	7.5	13.3	15
Conductance C	Nl/min · bar	121.43	264.26	505.52	971.43
Critical ratio b	bar/bar	0.32	0.27	0.32	0.43
Flow rate at 6 bar ΔP 0.5 bar	Nl/min	400	750	1560	3200
Flow rate at 6 bar ΔP 1 bar	Nl/min	550	1100	2150	4600
Installation		In any position (vertical assembly is not recommended for bistable valves subjected to vibration)			
Fluid		Filtered air without lubrication; lubrication, if used, must be continuous.			
Recommended lubricant		For series 70 LT (low-temperature) versions, it is recommended to use of perferamente dried air. ISO and UNI FD 22			
Maximum coil nut torque	Nm	For series 70 LT (low-temperature) it is not expected to be used with lubricated air.			
Compatibility with oils		1 See chapter Z1			

### COMPONENTS SERIES 70

- ① VALVE BODY: Aluminium
- ② CONTROL/END CAP: plastic
- ③ SPOOL: chemically nickel-plated aluminium
- ④ DISTANCE PLATES: plastic
- ⑤ GASKETS: NBR
- ⑥ PISTONS: Hostaform®
- ⑦ PISTON GASKET: NBR
- ⑧ FILTER: plastic
- ⑨ SPRINGS: special steel
- ⑩ OPERATOR: Brass pipe - Stainless steel core



**COMPONENTS SERIES 70 LT (LOW TEMPERATURE)**

- ① ALVE BODY: aluminium
- ② CONTROL/END CAP: aluminium
- ③ SPOOL: chemically nickel-plated aluminium
- ④ DISTANCE PLATES: plastic
- ⑤ GASKETS: HNBR
- ⑥ PISTONS: aluminium
- ⑦ PISTON GASKET: HNBR
- ⑧ FILTER: plastic
- ⑨ SPRINGS: special steel
- ⑩ OPERATOR: brass pipe - Stainless steel core  
(version specific for low-temperature applications)



VALVES

VALVES SERIES 70

**FLOW CHARTS**

**VALVES SERIES 70 1/8"**

Flow rates



**VALVES SERIES 70 1/4"**

Flow rates



**VALVES SERIES 70 3/8"**

Flow rates



**VALVES SERIES 70 1/2"**

Flow rates



**VALVES SERIES 70, HAND OPERATED**

VALVES

VALVES SERIES 70, HAND OPERATED

TECHNICAL DATA		1/8"	1/4"	1/2"
Operating pressure range:				
• version with direct control	bar	Vacuum to 10		
• pilot-assisted version	bar	2.5 to 10		
Operating temperature range				
	°C	-10 to +60		
Nominal diameter				
	mm	5	7.5	15
Conductance C	Nl/min · bar	121.43	264.26	971.43
Critical ratio b	bar/bar	0.32	0.27	0.43
Flow rate at 6 bar ΔP 0.5 bar	Nl/min	400	750	3200
Flow rate at 6 bar ΔP 1 bar	Nl/min	550	1100	4600



SYNOPTIC, SIZES AND VERSIONS					
M A V FAMILY	2 DIMENSIONS	3 FUNCTION	P P OPERATORS 14	S RESETTING (12)	N C FURTHER DETAILS
MAV manual valves	2 1/8" 3 1/4" 4 1/2"	3 3/2 5 5/2 6 5/3 8 2 x 3/2	PP drawer VL axial lever LE 90° lever BRE arranged for manual panel actuators	A pneumatic/mechanical springs* S mechanical springs B bistable D differential O stable for 5/3	NC normally closed NO normally open OO no indication CC closed centres OC open centres PC pressure centres

\*on demand

**VALVES SERIES 70, HAND OPERATED, 1/8"**

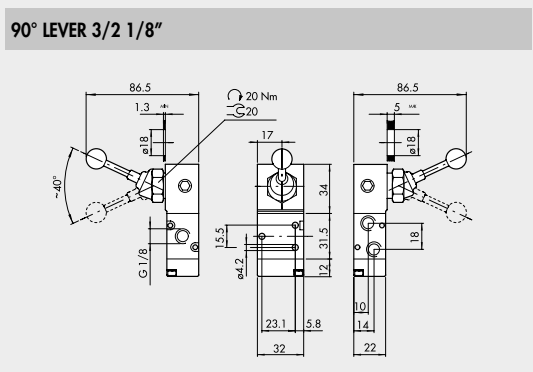

Symbol	Code	Abbrev.	Weight [g]
	7010000100	MAV 23 LES NC	168
	7010000200	MAV 23 LEB OO	171

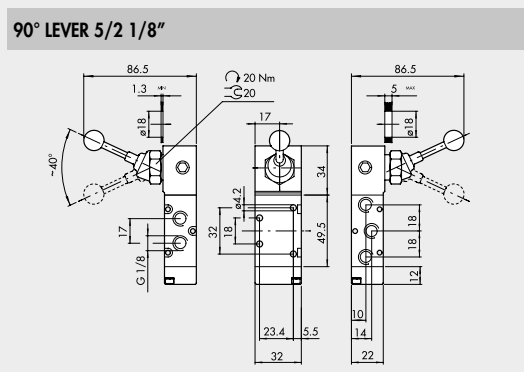

Symbol	Code	Abbrev.	Weight [g]
	7010000300	MAV 25 LES OO	194
	7010000400	MAV 25 LEB OO	197

**FRONT LEVER 3/2, 1/8"**



Symbol	Code	Abbrev.	Weight [g]
	7010001400	MAV 23 VLB OO	130

**FRONT LEVER 5/2, 1/8"**



Symbol	Code	Abbrev.	Weight [g]
	7010001700	MAV 25 VLB OO	156

VALVES

VALVES SERIES 70, HAND OPERATED



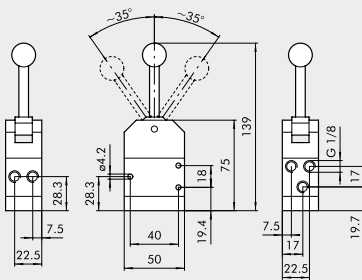

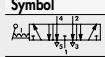
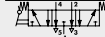

**FRONT LEVER 5/3, 1/8"**

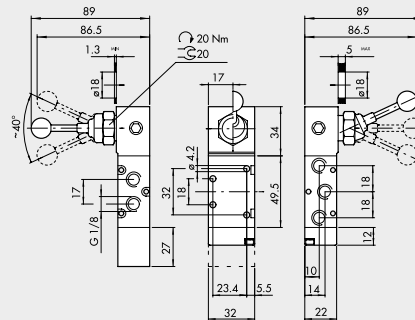

Symbol	Code	Abbrev.	Weight [g]
	7010001150	MAV 28 VLO OC	316
	7010001160	MAV 28 VLS OC	325

**90° LEVER 5/3, 1/8"**



Symbol	Code	Abbrev.	Weight [g]
	7010001000	MAV 26 LES CC	242
	7010000900	MAV 26 LES OC	242
	7010001100	MAV 26 LES PC	242
	7010000500	MAV 26 LEO CC	194
	7010000600	MAV 26 LEO OC	194
	7010000700	MAV 26 LEO PC	194

B1

VALVES

VALVES SERIES 70, HAND OPERATED

**DRAWER 3/2, 1/8"**

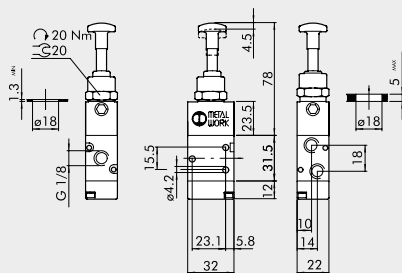

Symbol	Code	Abbrev.	Weight [g]
	7010001300	MAV 23 PPB OO	134
	7010001200	MAV 23 PPS NC	134

**DRAWER 5/2, 1/8"**

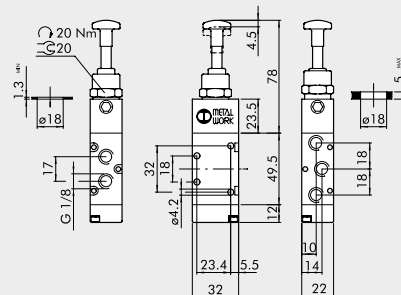

Symbol	Code	Abbrev.	Weight [g]
	7010001600	MAV 25 PPB OO	160
	7010001500	MAV 25 PPS OO	160

**PILOT-ASSISTED PLUNGER 3/2 1/8" FOR PANEL ACTUATORS**

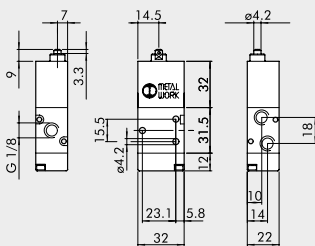

Symbol	Code	Abbrev.	Weight [g]
	7010001800	MAV 23 BRE NC	124

**PILOT-ASSISTED PLUNGER 5/2 1/8" FOR PANEL ACTUATORS**

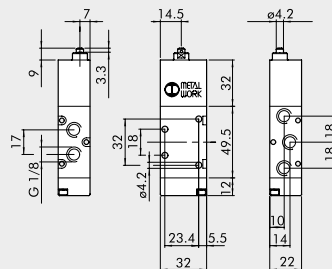

Symbol	Code	Abbrev.	Weight [g]
	7010001900	MAV 25 BRE OO	150

B1.16

ASSEMBLY DIAGRAM FOR PILOT-ASSISTED HAND-OPERATED VALVES SERIES 70 WITH PANEL ACTUATORS

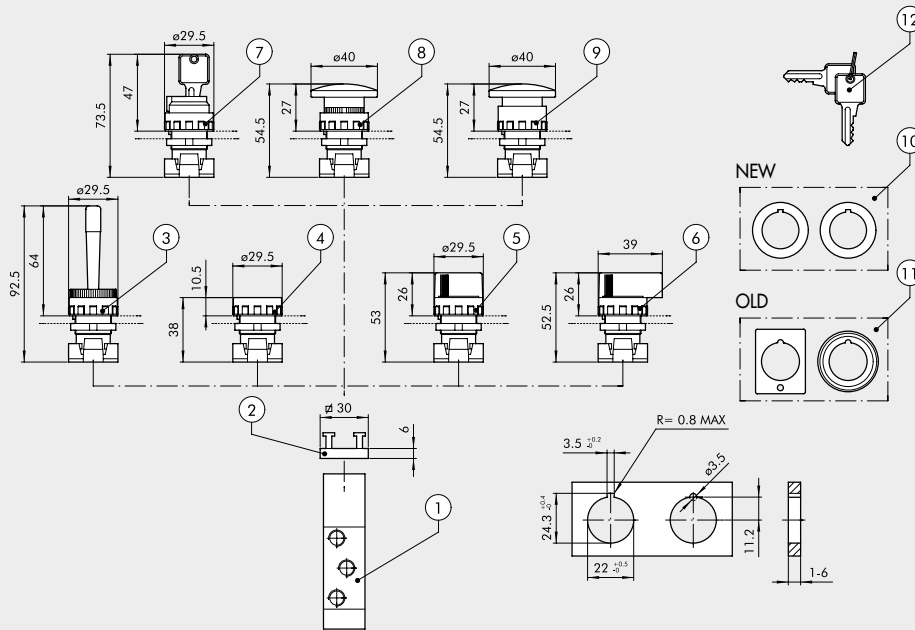

VALVES

VALVES SERIES 70, HAND OPERATED

ORDERING CODES

Symbol	Reference	Code	Description	Weight [g]
	①	7010001800	Pilot-assisted plunger 3/2, 1/8"	124
	①	7010001900	Pilot-assisted plunger 5/2, 1/8"	150
	②	0351000050	2 places adaptor thickness 6.8 mm	5
	③	W0351000015	Red handler with horizontally pivoted lever	25
	④	W0351000011	Fat push button + 2 red/black coloured disks ◆ Bistable fat push button without disk	15
	⑤	W0351000030	Black selector short lever at 2 positions with return	20
	⑤	W0351000031	Black selector short lever at 2 positions	20
	⑤	W0351000032	Black selector short lever at 3 positions with return	20
	⑤	W0351000033	Black selector short lever at 3 positions	20
	⑥	W0351000034	Black selector long lever at 2 positions with return	26
	⑥	W0351000035	Black selector long lever at 2 positions	26
	⑥	W0351000036	Black selector long lever at 3 positions with return	26
	⑥	W0351000037	Black selector long lever at 3 positions	26
	⑦	W0351000016	2 positions key selector with extractable key in 2 positions	50
	⑦	W0351000018	2 positions key selector with extractable key in 0	50
	⑧	W0351000013	Red mushroom-head push button Ø 40	27
	⑧	W0351000017	Black mushroom-head push button Ø 40	27
	⑨	W0351000014	Red mushroom-head push button with lock Ø 40	29
◆ It can't be supplied. As working replaced by selector with bistable short lever at 2 positions (⑤).	⑩	W0351000049	◆ Reducer from 30 to 22.5 mm	
♣ Usable only with technopolymer body selectors.	⑪	W0351000050	♣ Adapter for bore Ø 30 G2326	
▲ Usable only with metal body selectors.	⑫	W0351000021	▲ Key for ESC selectors	
		W0351000056	Green disk for push button (④)	



## Accessories

	Art. No.	Type No.
Pushbutton with red or black disc, monostable	106444	DK-M
Hand lever, red, monostable	106445	HH-M
Short wing lever, black, 2 positions, monostable	106446	KDH-2M
Short wing lever, black, 2 positions, bistable	106447	KDH-2B
Short wing lever, black, 3 positions, monostable	106448	KDH-3M
Short wing lever, black, 3 positions, bistable	106449	KDH-3B
Long wing lever, black, 2 positions, monostable	106450	LDH-2M
Long wing lever, black, 3 positions, monostable	106452	LDH-3M
Long wing lever, black, 3 positions, bistable	106453	LDH-3B
Mushroom pushbutton, red, monostable	106456	RPT-M
Mushroom pushbutton and emergency latch, red	106457	RPT-NR

## Spareparts

	Art. No.	Type No.
Plunger valve, 3/2-way, monostable, NC, G 1/8	106441	515.101
Long wing lever, black, 2 positions, bistable	106451	LDH-2B
Adapter max. 2 valves, required for mounting on basic valve	106443	A2V