

Shut-off valve

stainless steel

STAINLESS STEEL

Art. No. 103795

Type No. 250.50 ES

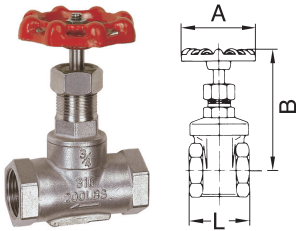

Exemplary illustration

Technical data

Housing	Stainless steel 1.4401 / 1.4408
Internal parts	Stainless steel 1.4401 / 1.4408
Wheel	Aluminium
Sealant	PTFE
Max. operating pressure	14 bar
Max. medium temperature	160 °C
Max. ambient temperature	160 °C
Operating temperature	-10 to 180 °C
Thread	G 3/8
Flow rate kv value	2.5 m ³ /h
DN	10
Weight	0.3 kg
A	70.0 mm
B min.	89.0 mm
B max.	99.0 mm
L	52.0 mm

Commercial data

Customs tariff number	84818063
Country of origin	CN
eCl@ss 5.1.4	27292002
eCl@ss 9.0	27292002
UNSPSC_Code_v190501	40141603
UNSPSC_CodeDesc_v190501	Pneumatic valves

Material informations

REACH SVHC1 substance name	no
CAS no. SVHC 1	no CAS No.
REACH Info	no SVHC substance included

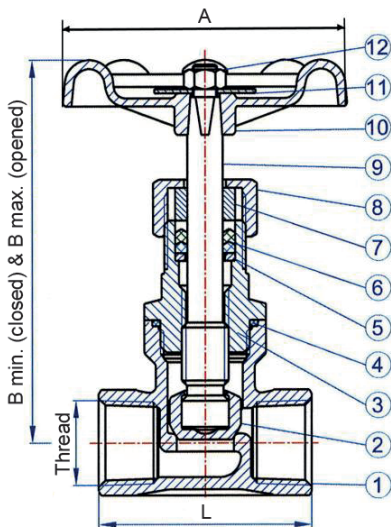

Nr.	Part name	Material
1	Body	CF8M
2	Disc	CF8M
3	Bonnet	CF8M
4	Gasket	PTFE
5	Whorl gasket	SUS304
6	Packing	PTFE
7	Gland	SUS304
8	Cap nut	CF8M
9	Stem	SUS316
10	Handle	Aluminium
11	Nameplate	Aluminium
12	Nut	SUS304